

**2005  
Magnum 330 2X4  
Magnum 330 4X4  
Owner's Manual  
for Maintenance and Safety**



**POLARIS**<sup>®</sup>  
The Way Out.

**Read this manual carefully. It contains important safety information.  
This is an adult vehicle only.  
Operation is prohibited for those under 16 years of age.**

## **⚠ WARNING**

**Improper vehicle use can result in SEVERE INJURY or DEATH.**



**ALWAYS USE  
AN APPROVED  
HELMET AND  
PROTECTIVE  
GEAR**



**NEVER USE  
ON PUBLIC  
ROADS**



**NEVER CARRY  
PASSENGERS**



**NEVER USE  
WITH DRUGS  
OR ALCOHOL**

### **NEVER:**

- Operate without proper training or instruction.
- Operate on public roads. A collision can occur with another vehicle.
- Operate at speeds too fast for your skills or the conditions.
- Use **ALCOHOL** or **DRUGS** before or while operating this vehicle.
- Carry Passengers.

### **ALWAYS:**

- Avoid paved surfaces, which may adversely affect handling and control.
- Use proper **RIDING TECHNIQUES** to avoid vehicle overturns on hills and rough terrain, and in turns.
- Wear eye protection, helmet and protective apparel.

**READ OWNER'S MANUAL.  
FOLLOW ALL INSTRUCTIONS AND WARNINGS.**

**Part No. 9919487 Rev 01  
PRINTED IN THE USA**



**POLARIS®**  
The Way Out.

 **WARNING**

The engine exhaust from this product contains chemicals known to cause cancer, birth defects or other reproductive harm.

A card containing important ATV safety information should be attached to the owner's manual on the next page. If you cannot locate this card, or if it has been removed, please call 1-800-342-3764 for assistance.



**POLARIS**

*For 50 years we've been  
helping Polaris customers  
find The Way Out.*

*It's been a fun ride.  
But then, after all these years,  
That's what we're all about.*

Find out more about our  
exciting once-in-a-lifetime  
50th Anniversary celebration:  
Go to [www.polarisindustries.com](http://www.polarisindustries.com)  
and look for the  
50th Anniversary link.

*This is a ride  
you don't  
want to miss!*



**POLARIS**  
The Way Out.

Copyright 2004 Polaris Sales Inc. All information contained within this publication is based on the latest product information at the time of publication. Due to constant improvements in the design and quality of production components, some minor discrepancies may result between the actual vehicle and the information presented in this publication. Depictions and/or procedures in this publication are intended for reference use only. No liability can be accepted for omissions or inaccuracies. Any reprinting or reuse of the depictions and/or procedures contained within, whether whole or in part, is expressly prohibited.

Printed in U.S.A.

2005 Magnum 330 2X4/4X4 Owner's Manual P/N 9919487

# WELCOME

Thank you for purchasing a Polaris vehicle, and welcome to our world-wide family of Polaris owners. We proudly produce an exciting line of utility and recreational products.

## **Polaris Recreational and Utility Vehicles**

- Snowmobiles
- All-terrain vehicles (ATVs)
- Watercraft
- Victory motorcycles
- *RANGER* utility vehicles

We believe Polaris sets a standard of excellence for all utility and recreational vehicles manufactured in the world today. Many years of experience have gone into the engineering, design, and development of your Polaris vehicle, making it the finest machine we've ever produced.

For safe and enjoyable operation of your vehicle, be sure to follow the instructions and recommendations in this owner's manual. Your manual contains instructions for minor maintenance, but information about major repairs is outlined in the Polaris Service Manual and should be performed only by a Factory Certified Master Service Dealer (MSD) Technician.

Your Polaris dealer knows your vehicle best and is interested in your total satisfaction. Be sure to return to your dealership for all of your service needs during, and after, the warranty period.

We also take great pride in our Parts Apparel and Accessories (PAA) products, available through our online store at [www.purepolaris.com](http://www.purepolaris.com). Have your accessories and clothing delivered right to your door!

POLARIS and POLARIS THE WAY OUT are registered trademarks of Polaris Industries Inc.



# TABLE OF CONTENTS

WELCOME .....	3
VEHICLE IDENTIFICATION NUMBERS .....	7
SAFETY .....	8
FEATURES AND CONTROLS .....	34
OPERATION .....	50
EMISSION CONTROL SYSTEMS .....	67
MAINTENANCE AND LUBRICATION .....	68
POLARIS PRODUCTS .....	108
SPECIFICATIONS .....	109
TROUBLESHOOTING .....	115
WARRANTY .....	119
INDEX .....	122





# VEHICLE IDENTIFICATION NUMBERS

Record your ATV's identification numbers and key number in the spaces provided. Remove the spare key and store it in a safe place. Your key can be duplicated only by mating a Polaris key blank with one of your existing keys, so if both keys are lost, the ignition switch must be replaced.

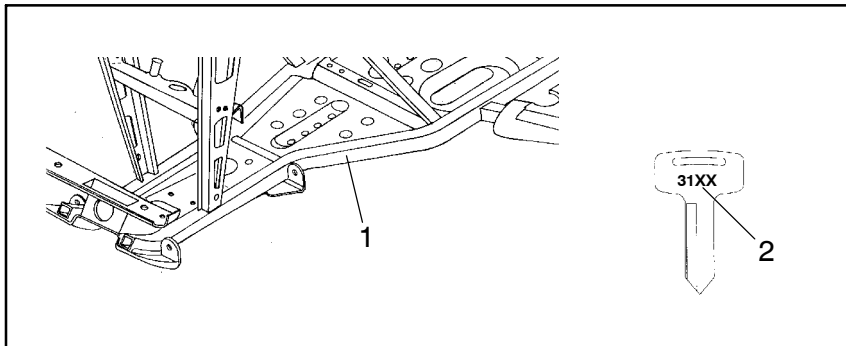

Vehicle Model Number: \_\_\_\_\_

Frame VIN (1): \_\_\_\_\_

Engine Serial Number: \_\_\_\_\_  
(right front side of engine crankcase)

Key Number (2): \_\_\_\_\_

# SAFETY

## Operator Safety

### WARNING

Failure to follow the warnings contained in this manual can result in serious injury or death.

A Polaris ATV is not a toy and can be hazardous to operate. This vehicle handles differently than other vehicles, such as motorcycles and cars. A collision or rollover can occur quickly, even during routine maneuvers like turning, or driving on hills or over obstacles, if you fail to take proper precautions.

Read and understand your owner's manual and all warnings before operating a Polaris ATV.

## Age Restrictions

This vehicle is an **ADULT VEHICLE ONLY**. Operation is prohibited for anyone under 16 years of age.

## Know Your Vehicle

As the operator of the vehicle, you are responsible for your personal safety, the safety of others, and the protection of our environment. Read and understand your owner's manual, which includes valuable information about all aspects of your vehicle, including safe operating procedures.

## Safety Training

When you purchased your new ATV, your dealer offered a hands-on safety training course that covers all aspects of vehicle safety. You were also provided with printed materials that explain safe operating procedures. You should review this information on a regular basis.

If you purchased a used Polaris ATV from a party other than a Polaris dealer, you can request this free safety training from any authorized Polaris dealer.

A Polaris ATV is an off-road vehicle. Familiarize yourself with all laws and regulations concerning the operation of this vehicle in your area.

We strongly advise you to strictly follow the recommended maintenance program outlined in your owner's manual. This preventive maintenance program is designed to ensure that all critical components on your vehicle are thoroughly inspected at specific intervals.

## Operator Safety

The following signal words and symbols appear throughout this manual and on your ATV. Your safety is involved when these words and symbols are used. Become familiar with their meanings before reading the manual.



The *safety alert symbol*, on your vehicle or in this manual, alerts you to the potential for personal injury.



### **WARNING**

The *safety alert warning* indicates a potential hazard that may result in serious injury or death.



### **CAUTION**

The *safety alert caution* indicates a potential hazard that may result in minor personal injury or damage to the vehicle.

### **CAUTION**

A *caution* indicates a situation that may result in damage to the vehicle.

#### **NOTE:**

A *note* will alert you to important information or instructions.

# SAFETY

## Operator Safety

### WARNING

Serious injury or death can result if you do not follow these instructions and procedures, which are outlined in further detail within your owner's manual.

- Read this manual and all labels carefully, and follow the operating procedures described.
- Never operate an ATV without proper instruction. *Take a training course.* Beginners should receive training from a certified instructor. Contact an authorized Polaris ATV dealer or call Polaris at 1-800-342-3764 to find out about the training courses nearest you.
- Never allow anyone under 16 years of age to operate this ATV.
- Never permit a guest to operate the ATV unless the guest has read this manual and all product labels and has completed a certified safety training course.
- Always avoid operating an ATV on paved surfaces, including sidewalks, driveways, parking lots, and streets.
- Never operate an ATV on a public street, road or highway, including a dirt or gravel road.
- Never operate an ATV without wearing an approved helmet that fits properly. Always wear eye protection (goggles or face shield), gloves, boots, a long-sleeved shirt or jacket, and long pants.
- Never consume alcohol or drugs before or while operating an ATV.
- Never operate at excessive speeds. Travel at speeds appropriate for the terrain, visibility and operating conditions, and your experience.
- Never attempt wheelies, jumps or other stunts.
- Always inspect your ATV before each use to make sure it's in safe operating condition. Always follow the inspection and maintenance procedures and schedules outlined in your owner's manual.
- Always keep both hands on the handlebars and both feet on the footrests of the ATV during operation.
- Always travel slowly and use extra caution when operating on unfamiliar terrain. Be alert to changing terrain conditions.
- Never operate on excessively rough, slippery, or loose terrain.
- Always follow proper turning procedures as described in this manual. Practice turning at low speeds before attempting to turn at faster speeds. Do not turn at excessive speeds.

## Operator Safety

- Always have the ATV inspected by an authorized Polaris dealer if it's been involved in an accident.
- Never operate on hills too steep for the ATV or for your abilities. Practice on smaller hills before attempting larger hills.
- Always follow proper procedures for climbing hills. Check the terrain carefully before ascend a hill. Never climb hills with excessively slippery or loose surfaces. Shift your weight forward. Never open the throttle suddenly or make sudden gear changes. Never go over the top of a hill at high speed.
- Always follow proper procedures for going downhill and for braking on hills. Check the terrain carefully before you start down a hill. Shift your weight backward. Never go down a hill at high speed. Avoid going down a hill at an angle, which would cause the vehicle to lean sharply to one side. Travel straight down the hill when possible.
- Always follow proper procedures for crossing the side of a hill. Avoid hills with excessively slippery or loose surfaces. Shift your weight to the uphill side of the ATV. Never attempt to turn the ATV around on any hill until you've mastered (on level ground) the turning technique outlined in this manual. Avoid crossing the side of a steep hill when possible.
- Always use proper procedures if you stall or roll backwards while climbing a hill. To avoid stalling, maintain a steady speed when climbing a hill. If you stall or roll backwards, follow the special procedure for braking described in this manual. Always dismount on the uphill side, or to either side if the ATV is pointed straight uphill. Turn the ATV around and remount following the procedure described in this manual.
- Always check for obstacles before operating in a new area. Never attempt to operate over large obstacles, such as rocks or fallen trees. Always follow proper procedures when operating over obstacles as described in this manual.
- Always be careful of skidding or sliding. On slippery surfaces like ice, travel slowly and use extra caution to reduce the chance of skidding or sliding out of control.
- Avoid operating the ATV through deep or fast-flowing water. If it's unavoidable, travel slowly, balance your weight carefully, avoid sudden movements, and maintain a slow and steady forward motion. Do not make sudden turns or stops, and do not make sudden throttle changes.

# SAFETY

## Operator Safety

- Wet brakes may have reduced stopping ability. Test your brakes after leaving water. If necessary, apply them lightly several times to allow friction to dry out the pads.
- Always check for obstacles or people behind the ATV before operating in reverse. When it's safe to proceed in reverse, move slowly and avoid turning at sharp angles.
- Always use the size and type of tires specified for your ATV, and always maintain tire pressure as recommended.
- Never modify an ATV through improper installation or use of accessories.
- Never exceed the stated load capacity for your ATV. Cargo must be properly distributed and securely attached. Reduce speed and follow the instructions in this manual for carrying cargo or towing. Allow a greater distance for braking.
- Always remove the ignition key when the vehicle is not in use to prevent unauthorized use or accidental starting.

**FOR MORE INFORMATION ABOUT ATV SAFETY, call the Consumer Product Safety Commission at 1-800-638-2772, or call Polaris at 1-800-342-3764.**

## Equipment Modifications

We are concerned for the safety of our customers and for the general public. Therefore, we strongly recommend that consumers do not install on a Polaris ATV any equipment that may increase the speed or power of the vehicle, or make any other modifications to the vehicle for these purposes. Any modifications to the original equipment of the vehicle create a substantial safety hazard and increase the risk of bodily injury.

The warranty on your Polaris ATV is terminated if any equipment has been added to the vehicle, or if any modifications have been made to the vehicle, that increase its speed or power.

**NOTE:** The addition of certain accessories, including (but not limited to) mowers, blades, tires, sprayers, or large racks, may change the handling characteristics of the vehicle. Use only Polaris-approved accessories, and familiarize yourself with their function and effect on the vehicle.

## Operator Safety

### **WARNING**

#### POTENTIAL HAZARD

Operating this ATV without proper instruction.

#### WHAT CAN HAPPEN

The risk of an accident is greatly increased if the operator does not know how to operate the ATV properly in different situations and on different types of terrain.

#### HOW TO AVOID THE HAZARD

Beginning and inexperienced operators should complete the certified training course offered by Polaris. Operators should regularly practice the skills learned in the course and the operating techniques described in the owner's manual.

For more information about the training course, contact an authorized ATV dealer or call Polaris at 1-800-342-3764.

### **WARNING**

#### POTENTIAL HAZARD

Failure to follow the age recommendations for this ATV.

#### WHAT CAN HAPPEN

Severe injury and/or death could occur if a child under the minimum age recommendation operates an ATV.

Even though a child may be within the recommended age group for operating some ATVs, he/she may not have the skills, abilities, or judgment needed to operate an ATV safely and could be susceptible to accident or injury.

#### HOW TO AVOID THE HAZARD

No one under the age of 16 should operate a Polaris ATV.



# SAFETY

## Operator Safety

### **⚠️ WARNING**

#### POTENTIAL HAZARD

Carrying a passenger on an ATV.

#### WHAT CAN HAPPEN

Carrying a passenger greatly reduces the operator's ability to balance and control the ATV, which could cause an accident and injury to the operator and/or passenger.

#### HOW TO AVOID THE HAZARD

Never carry a passenger. The purpose of the long seat is to allow the operator to shift position as needed during operation. It is not intended for carrying passengers.

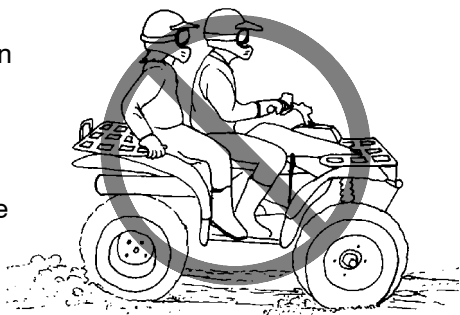

### **⚠️ WARNING**

#### POTENTIAL HAZARD

Operating an ATV on paved surfaces, including sidewalks, paths, parking lots, and driveways.

#### WHAT CAN HAPPEN

ATV tires are designed for off-road use. Operating on paved surfaces may seriously affect the handling and control of the ATV and could result in loss of control, accident, and/or injury.

#### HOW TO AVOID THE HAZARD

Avoid operating the ATV on pavement. If it's unavoidable, travel slowly and avoid sudden turns or stops.

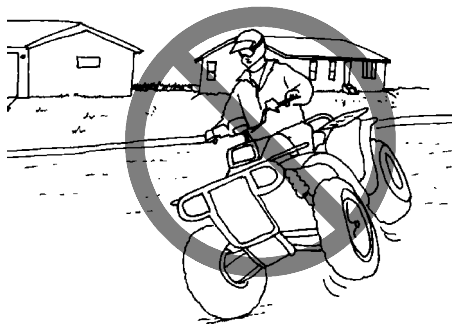

## Operator Safety

### **⚠️ WARNING**

#### POTENTIAL HAZARD

Operating this ATV on public streets, roads or highways.

#### WHAT CAN HAPPEN

The ATV could collide with another vehicle.

#### HOW TO AVOID THE HAZARD

Never operate the ATV on any public street, road or highway, including dirt and gravel roads. In many states it's illegal to operate ATVs on public streets, roads and highways.

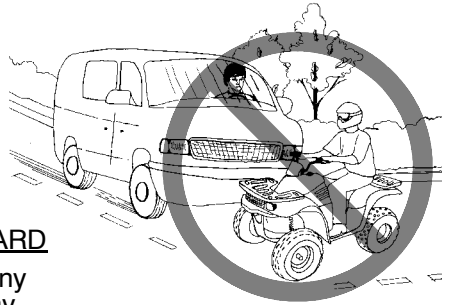

### **⚠️ WARNING**

#### POTENTIAL HAZARD

Operating this ATV without wearing an approved helmet, eye protection and protective clothing.

#### WHAT CAN HAPPEN

Operating an ATV without an approved helmet increases the risk of a severe head injury or death in the event of an accident.

Operating without eye protection could result in an accident and could increase the chance of a severe injury in the event of an accident.

#### HOW TO AVOID THE HAZARD

Always wear an approved helmet that fits properly.

Always wear eye protection (goggles or face shield), gloves, boots, long-sleeved shirt or jacket, and long pants.



# SAFETY

## Operator Safety

### **⚠ WARNING**

#### POTENTIAL HAZARD

Operating the ATV after consuming alcohol or drugs.

#### WHAT CAN HAPPEN

Consumption of alcohol and/or drugs could seriously affect operator judgment. Reaction time may be slower and operator balance and perception could be affected.

Consuming alcohol and/or drugs before or while operating an ATV could result in an accident causing severe injury or death.

#### HOW TO AVOID THE HAZARD

Never consume alcohol or drugs before or while operating an ATV.



### **⚠ WARNING**

#### POTENTIAL HAZARD

Operating the ATV at excessive speeds.

#### WHAT CAN HAPPEN

Excessive speed increases the operator's chance of losing control of the ATV, which can result in an accident.

#### HOW TO AVOID THE HAZARD

Always operate the ATV at a speed that's proper for the terrain, visibility and operating conditions, and your experience.

## Operator Safety

### **⚠ WARNING**

#### POTENTIAL HAZARD

Attempting wheelies, jumps and other stunts.

#### WHAT CAN HAPPEN

Attempting stunts increases the chance of an accident, including an overturn.

#### HOW TO AVOID THE HAZARD

Never attempt wheelies, jumps, or other stunts. Avoid exhibition driving.

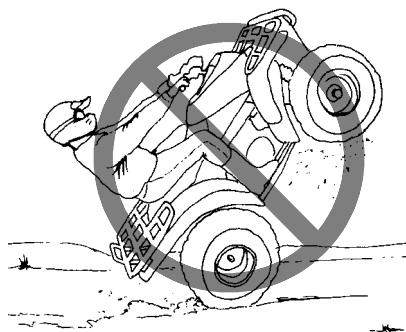

### **⚠ WARNING**

#### POTENTIAL HAZARD

Failure to inspect the ATV before operating.

Failure to properly maintain the ATV.

#### WHAT CAN HAPPEN

Poor maintenance increases the possibility of an accident or equipment damage.

#### HOW TO AVOID THE HAZARD

Always inspect your ATV before each use to make sure it's in safe operating condition.

Always follow the inspection and maintenance procedures and schedules described in the owner's manual.

# SAFETY

## Operator Safety

### **⚠️ WARNING**

#### POTENTIAL HAZARD

Removing hands from the handlebars or feet from the footrests during operation.

#### WHAT CAN HAPPEN

Removing even one hand or foot can reduce ability to control the vehicle or could cause loss of balance and ejection from the ATV.

If the operator's foot is not firmly planted on the footrest, it could come into contact with the rear wheels and lead to accident or injury.

#### HOW TO AVOID THE HAZARD

Always keep both hands on the handlebars and both feet on the footrests of the ATV during operation.

### **⚠️ WARNING**

#### POTENTIAL HAZARD

Failure to use extra caution when operating the ATV on unfamiliar terrain.

#### WHAT CAN HAPPEN

Unfamiliar terrain may contain hidden rocks, bumps, or holes that could cause loss of control or overturn.

#### HOW TO AVOID THE HAZARD

Travel slowly and use extra caution when operating on unfamiliar terrain. Always be alert to changing terrain conditions.

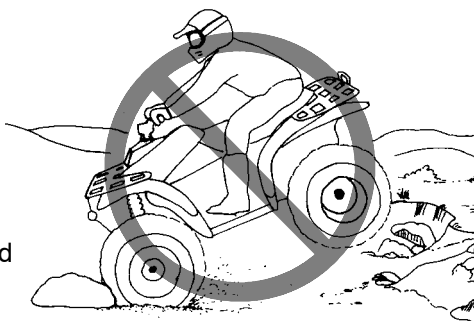

## Operator Safety

### **⚠ WARNING**

#### POTENTIAL HAZARD

Failure to use extra caution when operating on excessively rough, slippery or loose terrain.

#### WHAT CAN HAPPEN

Operating on excessively rough, slippery or loose terrain could cause loss of traction or loss of control, which could result in an accident or overturn.

#### HOW TO AVOID THE HAZARD

Do not operate on excessively rough, slippery or loose terrain until you've learned and practiced the skills necessary to control the ATV on such terrain.

Always use extra caution on rough, slippery or loose terrain.

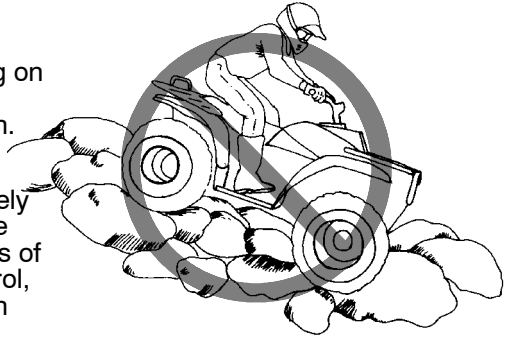

### **⚠ WARNING**

#### POTENTIAL HAZARD

Turning improperly.

#### WHAT CAN HAPPEN

Improper turns could cause loss of control and lead to a collision or overturn.

#### HOW TO AVOID THE HAZARD

Always follow proper procedures for turning as described in the owner's manual.

Practice turning at slow speeds before attempting to turn at faster speeds.

Never turn at excessive speed.

# SAFETY

## Operator Safety

### **⚠ WARNING**

#### POTENTIAL HAZARD

Operating on excessively steep hills.

#### WHAT CAN HAPPEN

The vehicle may overturn.

#### HOW TO AVOID THE HAZARD

Never operate on hills too steep for the ATV or for your abilities. Never operate the ATV on hills steeper than 25°.

Practice on smaller hills before attempting large hills.

### **⚠ WARNING**

#### POTENTIAL HAZARD

Climbing hills improperly.

#### WHAT CAN HAPPEN

Improper hill climbing could cause loss of control or overturn.

#### HOW TO AVOID THE HAZARD

Always follow proper procedures for climbing hills as described in the owner's manual.

Always check the terrain carefully before ascending any hill.

Never operate the ATV on hills steeper than 25°.

Never climb hills with excessively slippery or loose surfaces.

Shift your weight forward.

Never open the throttle suddenly while traveling uphill. The ATV could flip over backwards.

Never go over the top of any hill at high speed. An obstacle, a sharp drop, or another vehicle or person could be on the other side of the hill.

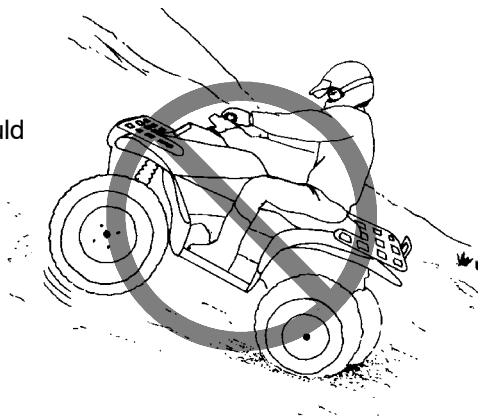

## Operator Safety

### **⚠ WARNING**

#### POTENTIAL HAZARD

Traveling downhill improperly.

#### WHAT CAN HAPPEN

Improperly descending a hill could cause loss of control or overturn.

#### HOW TO AVOID THE HAZARD

Always follow proper procedures for traveling down hills as described in the owner's manual. **NOTE:** A special technique is required when braking while traveling downhill. See page 61.

Always check the terrain carefully before descending a hill.

Shift your weight backward.

Never travel down a hill at high speed.

Avoid traveling down a hill at an angle, which would cause the vehicle to lean sharply to one side. Travel straight down the hill when possible.





# SAFETY

## Operator Safety

### **⚠ WARNING**

#### POTENTIAL HAZARD

Improperly crossing hills and turning on hills.

#### WHAT CAN HAPPEN

Improperly crossing or turning as hills could cause loss of control or overturn.

#### HOW TO AVOID THE HAZARD

Never attempt to turn the ATV around on any hill until you've mastered the turning technique (on level ground) as described in the owner's manual. See page 62. Use extra caution when turning on any hill.

Avoid crossing the side of a steep hill.

#### When crossing the side of a hill:

Always follow proper procedures as described in the owner's manual.

Avoid hills with excessively slippery or loose surfaces.

Shift your weight to the uphill side of the ATV.



## Operator Safety

### **⚠ WARNING**

#### POTENTIAL HAZARD

Stalling, rolling backwards or improperly dismounting while climbing a hill.

#### WHAT CAN HAPPEN

The vehicle could overturn.

#### HOW TO AVOID THE HAZARD

Maintain steady speed when climbing a hill.

#### If all forward speed is lost:

Keep your weight uphill.

Apply the single lever brake gradually.

When fully stopped, apply the auxiliary rear brake as well, then lock the parking brake.

#### If the ATV begins rolling backwards:

Keep weight uphill.

Never apply engine power.

Never apply the auxiliary rear brake while rolling backwards.

Apply the single-lever brake gradually.

When fully stopped, apply the auxiliary rear brake as well, and then lock the parking brake.

Dismount on uphill side, or to either side if ATV is pointed straight uphill.

Turn the ATV around and remount, following the procedure described in the owner's manual. See page 62.



# SAFETY

## Operator Safety

### **WARNING**

#### POTENTIAL HAZARD

Improperly operating over obstacles.

#### WHAT CAN HAPPEN

Operating over obstacles could cause loss of control or overturn.

#### HOW TO AVOID THE HAZARD

Before operating in a new area, check for obstacles.

Avoid operating over large obstacles such as rocks and fallen trees when possible. If unavoidable, use extreme caution and always follow proper procedures as outlined in the owner's manual.

### **WARNING**

#### POTENTIAL HAZARD

Skidding or sliding.

#### WHAT CAN HAPPEN

Skidding or sliding can cause loss of control.

If the tires regain traction unexpectedly, the ATV could overturn.

#### HOW TO AVOID THE HAZARD

On slippery surfaces such as ice, travel slowly and use extra caution to reduce the chance of skidding or sliding out of control.

### **WARNING**

#### POTENTIAL HAZARD

Improperly operating in reverse.

#### WHAT CAN HAPPEN

The ATV could collide with an obstacle or person, resulting in severe injury.

#### HOW TO AVOID THE HAZARD

Before shifting into reverse gear, always check for obstacles or people behind the ATV. When it's safe to proceed, back slowly.

## Operator Safety

### **WARNING**

#### POTENTIAL HAZARD

Operating the ATV through deep or fast-flowing water.

#### WHAT CAN HAPPEN

Tires may float, causing loss of traction and loss of control, which could lead to an accident or overturn.

#### HOW TO AVOID THE HAZARD

Avoid operating the ATV through deep or fast-flowing water. If it's unavoidable to enter water that exceeds the recommended maximum depth (see page 63), travel slowly, balance your weight carefully, avoid sudden movements, and maintain a slow and steady forward motion. Do not make sudden turns or stops, and do not make sudden throttle changes.

Wet brakes may have reduced stopping ability. Always test the brakes after leaving water. If necessary, apply them several times to let friction dry out the pads.

### **WARNING**

#### POTENTIAL HAZARD

Operating this ATV with improper tires, or with improper or uneven tire pressure.

#### WHAT CAN HAPPEN

Use of improper tires, or operation of the ATV with improper or uneven tire pressure, could cause loss of control or accident.

#### HOW TO AVOID THE HAZARD

Always use the size and type of tires specified for the ATV.

Always maintain proper tire pressure as specified.

# SAFETY

## Operator Safety

### **WARNING**

#### POTENTIAL HAZARD

Operating the ATV with improper modifications.

#### WHAT CAN HAPPEN

Improper installation of accessories or modification of the ATV may cause changes in handling which could lead to an accident.

#### HOW TO AVOID THE HAZARD

Never modify the ATV through improper installation or use of accessories. All parts and accessories added to the vehicle must be genuine Polaris Industries Inc. or equivalent components designed for use on this ATV and should be installed and used according to approved instructions. See your authorized Polaris ATV dealer for more information.

### **WARNING**

#### POTENTIAL HAZARD

Overloading the ATV or carrying/towing cargo improperly.

#### WHAT CAN HAPPEN

Overloading and towing can cause changes in vehicle handling, which could lead to loss of control or an accident.

#### HOW TO AVOID THE HAZARD

Never exceed the stated load capacity for this ATV.

Cargo should be properly distributed and securely attached.

Reduce speed when carrying cargo or pulling a trailer. Allow a greater distance for braking.

Always follow the instructions in the owner's manual for carrying cargo or pulling a trailer. See page 56.

### **WARNING**

#### POTENTIAL HAZARD

Operating on frozen bodies of water.

#### WHAT CAN HAPPEN

Severe injury or death can result if the ATV and/or the operator fall through the ice.

#### HOW TO AVOID THE HAZARD

Never operate the ATV on a frozen body of water.

## Operator Safety

### **WARNING**

Leaving the keys in the ignition can lead to unauthorized use of the vehicle resulting in serious injury or death. Always remove the ignition key when the vehicle is not in use.

### **WARNING**

After any overturn or accident, have a qualified service dealer inspect the entire vehicle for possible damage, including (but not limited to) brakes, throttle and steering systems.

### **WARNING**

Safe operation of this rider-active vehicle requires good judgement and physical skills. Persons with cognitive or physical disabilities who operate this vehicle have an increased risk of overturn and loss of control, which could result in severe injury or death.

### **CAUTION**

Always keep combustible materials away from the exhaust system. Exposure to the hot components could result in a fire.

# SAFETY

## Safety Decals and Locations

Warning decals have been placed on the ATV for your protection. Read and follow the instructions of the decals and other warnings on the ATV carefully. If any of the decals shown in this manual differ from the decals on your ATV, always read and follow the instructions of the decals *on the ATV*.

If any decal becomes illegible or comes off, contact your Polaris dealer to purchase a replacement. Replacement *safety* decals are provided by Polaris at no charge. The part number is printed on the decal.

**NOTE:** Your ATV may not have all of the decals shown. Decals vary depending on the model.

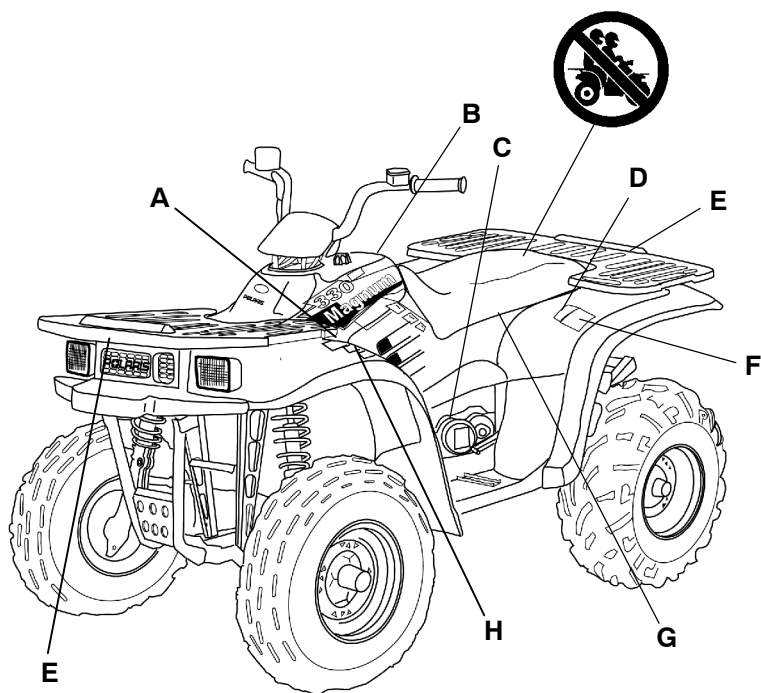

## Safety Decals and Locations

<b>⚠ WARNING</b>
<ul style="list-style-type: none"> <li>• Never operate this ATV on HILLS steeper than 25 degrees . To prevent flipover on hilly terrain, when going up or down, use throttle and brakes gradually.</li> <li>• REVERSE operation can be dangerous even at low speeds. Steering becomes difficult. To prevent flipover, avoid sudden braking or sharp turns.</li> <li>• Use OVERRIDE for reverse speed limiter with caution. To prevent loss of control, never activate override button with open throttle.</li> <li>• When this ATV is not in operation or unattended, place shift in the park position.</li> </ul>
7172561

Location A

<b>⚠ WARNING</b>

<p>Operating this ATV if you are under the age of 16 increases your chance of severe injury or death.</p> <p><b>NEVER</b> operate this ATV if you are under age 16.</p>
7172559

Location B

<b>⚠ WARNING</b>
<ul style="list-style-type: none"> <li>• Moving parts hazard under belt-clutch guard. To prevent serious injury, do not operate vehicle with guard removed.</li> <li>• Do not modify engine or clutch. Doing so can cause part failure, possible imbalance, and excessive engine RPM, which can result in serious injury or death.</li> </ul>

<b>⚠ WARNING</b>
<b>NEVER</b> ride as a passenger

<p>Passengers can cause a loss of control, resulting in <b>SEVERE INJURY</b> or <b>DEATH</b></p>
7172566

Location D

<b>NO STEP</b>
7172563

Location C

<b>⚠ WARNING</b>
<ul style="list-style-type: none"> <li>• <b>DO NOT TOW FROM RACK OR BUMPER.</b> Vehicle damage or tipover may result causing severe injury or death. Tow only from tow hooks or hitch.</li> <li>• Max Rack Loads: Front 90 lbs. (41 kg) Rear 180 lbs. (82 kg)</li> </ul>
7172572

Location E (on models with racks)

<b>⚠ WARNING</b>
<p><b>DO NOT TOW FROM RACK OR BUMPER.</b> Vehicle damage or tipover may result causing severe injury or death. Tow only from tow hooks or hitch. Max. combined Front Rack and container Load 90 lbs. (41 kg)</p>
7172569

Location E (on models with storage box)



# SAFETY

## Safety Decals and Locations

### **WARNING**

IMPROPER TIRE PRESSURE OR OVERLOADING can cause loss of control resulting in SEVERE INJURY OR DEATH.

**TIRE PRESSURE (PSI):** FRONT \_\_\_ REAR \_\_\_

**MAXIMUM WEIGHT CAPACITY** (Gross Vehicle Weight)  
INCLUDING MACHINE, DRIVER AND CARGO IS \_\_\_ LBS.

Reduce speed and allow greater distance for braking when carrying cargo. Overloading or carrying tall, off-center, or unsecured loads will increase your risk of losing control. Loads should be centered, carried as low as possible, and firmly secured to the racks. with dual racks, load distribution 1/3 front 2/3 rear is best. For stability on rough or hilly terrain, reduce speed and cargo. Do not block headlight. Be careful if load extends over the side of the rack.

Read Owner's Manual for more detailed loading information

### Location F

<ul style="list-style-type: none"><li>• Operation of this vehicle without the air filter element will severely damage the engine.</li><li>• Clean pre-filter element often, more frequent cleaning required in dusty conditions. Do not operate vehicle without pre-filter.</li></ul>	<p style="text-align: center;"><b>ATTENTION</b></p> <ul style="list-style-type: none"><li>• Specific carburetor jetting and adjustments are required depending on temperature and altitude. See your Owner's Manual.</li></ul> <p style="text-align: center;">Factory setting: 40° to 80° F. at 0-3000 feet (5° to 27° C. at 0-900 meters).</p> <p style="text-align: right;">7170007</p>
---	---

### Location G (Under Seat)

## Safety Decals and Locations

**⚠ WARNING**

Improper ATV use can result in SEVERE INJURY or DEATH



ALWAYS USE  
AN APPROVED  
HELMET AND  
PROTECTIVE  
GEAR



NEVER USE  
ON PUBLIC  
ROADS



NEVER CARRY  
PASSENGERS



NEVER USE  
WITH DRUGS  
OR ALCOHOL

**NEVER operate:**

- without proper training or instruction
- at speeds too fast for your skills or the conditions
- on public roads - a collision can occur with another vehicle
- with a passenger - passengers affect balance and steering and increase risk of losing control

**ALWAYS:**

- use proper riding techniques to avoid vehicle overturns on hills and rough terrain and in turns
- avoid paved surfaces - pavement may seriously affect handling and control

**LOCATE AND READ OWNER'S MANUAL.  
FOLLOW ALL INSTRUCTIONS AND WARNINGS.**

**IF OWNER'S MANUAL IS MISSING, CONTACT  
A POLARIS DEALER FOR A REPLACEMENT.**

© 1997, 2000 7172560

**ALL WHEEL  
DRIVE  
SWITCH**

Do not push switch to engage AWD if the rear wheels are spinning. This may cause severe drive shaft and clutch damage.  
See your Owner's Manual.

7079780

Applicable AWD Models

### Location H

**⚠ WARNING**

Pushing reverse override button may cause sudden increases in power and traction if too much throttle is applied. Loss of control or forward flipover may result, especially in AWD. See Owner's Manual.

7172564

AWD Models

**OVERRIDE  
SWITCH**

Reverse Speed is limited.

Reverse override is controlled by the override switch.

See your Owner's Manual.

7079906

2WD Models



**MANUFACTURED  
BY: POLARIS IND. INC.**

**DATE:**

**VIN:**

**THIS VEHICLE IS AN ALL TERRAIN VEHICLE AND IS NOT  
INTENDED FOR USE ON PUBLIC ROADS.**

**CE VÉHICULE EST UN VÉHICULE TOUT TERRAIN QUI N'EST  
PAS DESTINÉ À ÊTRE UTILISÉ SUR LES CHEMINS PUBLICS.**

PATENT NOTICE Mtd. by All Terrain Vehicle Division, Polaris Industries Inc. under one or more of the following patents: Other patents pending. U.S. Patents

4697665	5036939	5975624
6016943	6092877	6149540
6224134	6270106	6340186
D378080	D389440	D400143



7171492

Canadian Certification Decal

# SAFETY

## Safe Riding Gear

Always wear clothing suited to the type of riding. ATV riding requires special protective clothing for comfort and to reduce the chance of injury.

### 1. Helmet

Your helmet is the most important piece of protective gear for safe riding. A helmet can prevent a severe head injury.

Select an approved helmet that meets or exceeds your state's safety standards and bears either the Department of Transportation (DOT) label, the American National Standards Institute label (ANSI z90.1), or the Snell Memorial Foundation label.

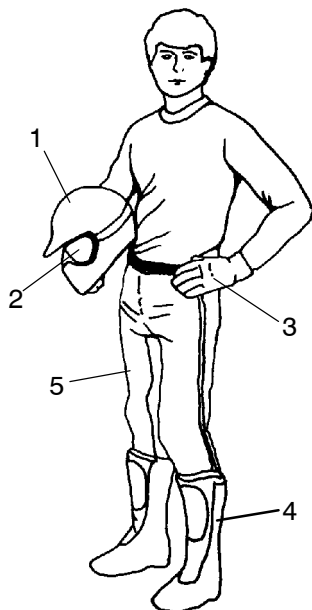

### 2. Eye Protection

Do not depend on sunglasses for proper eye protection. A pair of goggles or a helmet face shield offer the best protection for your eyes. They should be kept clean and be of shatterproof design (bearing the markings z2.1 or VESC 8).

### 3. Gloves

Off-road style gloves with knuckle pads are the best for comfort and protection.

### 4. Boots

The best footwear is a pair of strong over-the-calf boots with heels, like moto-cross boots.

### 5. Clothing

Always wear long sleeves and long pants to protect arms and legs. Riding pants with kneepads and a jersey with shoulder pads provide the best protection.

## Fuel Safety

### **WARNING**

Gasoline is highly flammable and explosive under certain conditions.

- Always exercise extreme caution whenever handling gasoline.
- Always refuel with the engine stopped, and outdoors or in a well ventilated area.
- Do not smoke or allow open flames or sparks in or near the area where refueling is performed or where gasoline is stored.
- Do not overfill the tank. Do not fill the tank neck.
- If gasoline spills on your skin or clothing, immediately wash it off with soap and water and change clothing.
- Never start the engine or let it run in an enclosed area. Engine exhaust fumes are poisonous and can cause loss of consciousness or death in a short time.
- Turn the fuel valve off whenever the ATV is stored or parked.

### **WARNING**

The engine exhaust from this product contains chemicals known to cause cancer, birth defects or other reproductive harm.

Operate this vehicle only outdoors or in well-ventilated areas.

# FEATURES AND CONTROLS

## Electrical Switches

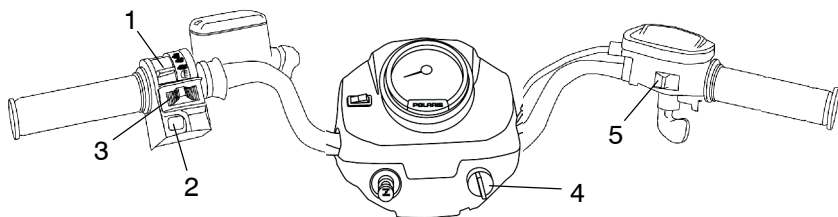

### **⚠ WARNING**

Operating the ATV on streets or roads, especially in darkness, could result in an accident and serious injury or death.

Your ATV is not equipped with highway-approved lights. It's designed for and must be used for *off-road use only*. Use caution and drive at reduced speeds in conditions of reduced visibility such as fog, rain and darkness.

1. **Light Switch/Hi-Lo Beam Control** - The lights won't turn on unless the main switch is on.

### **⚠ WARNING**

Activating the override switch while the throttle is open can cause loss of control, resulting in severe injury or death. Do not activate the override switch while the throttle is open.

2. **Override Switch (Reverse Speed Limiter)** - This vehicle is equipped with a reverse speed limiter system. To gain additional power while backing, depress the override switch.

**NOTE:** The override switch also allows activation of AWD in reverse if the AWD switch is on.

# FEATURES AND CONTROLS

## Electrical Switches

3. **Engine Stop Switch** - The engine will not start or run when the switch is in the *OFF* position. Its purpose is to provide the operator with a quick means of engine shutdown in case of an emergency. To stop the engine, slide the stop switch either right or left to the *OFF* position.

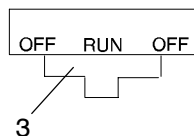

4. **Main Switch** - To start the engine, slide the stop switch to the center *RUN* position and turn the main key switch clockwise past the *ON* position. Release the key when the engine starts.

**NOTE:** Turn off the main switch to end all electrical power to the vehicle, including the cooling fan and lights.

5. **All Wheel Drive Switch (AWD Models)** Select AWD models do not have an AWD switch. These models are continuously in AWD.

# FEATURES AND CONTROLS

## Throttle Lever

Engine speed and vehicle movement are controlled by pressing the throttle lever. The throttle lever (1) is spring loaded. Engine speed returns to idle when the lever is released.

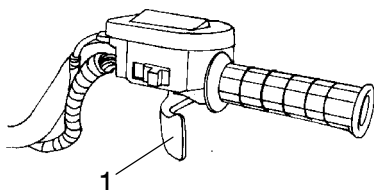

This ATV is equipped with Polaris Electronic Throttle Control (ETC), which is designed to reduce the risk of a frozen or stuck throttle. If the throttle cable should stick in an open position when the operator releases the throttle lever, the engine will stop, and power to the rear wheels will cease.

### **WARNING**

Operating an ATV with sticking or improperly operating throttle controls could cause an accident and lead to severe injury or death.

Never start or operate an ATV with a sticking or improperly operating throttle. Always contact your dealer for service if throttle problems arise.

Failure to check or maintain proper operation of the throttle system can result in an accident if the throttle lever sticks during operation. Always check the lever for free movement and return before starting the engine. Also check occasionally during operation.

### **WARNING**

The Electronic Throttle Control (ETC) stops the engine in the event of a throttle system malfunction and is provided for your safety. Do not attempt to modify the ETC system or replace it with any after market throttle mechanisms.

# FEATURES AND CONTROLS

## Brakes

### Master Cylinder

Check the brake fluid level in the master cylinder before each use of the ATV. The master cylinder (1) is located on the left handlebar.

View the fluid level through the indicator window (2) on the top of the master cylinder. This eye will appear dark when the fluid level is full. When fluid is low, the eye will be clear.

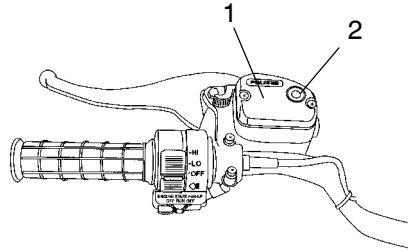

**NOTE:** When checking the fluid level, position the ATV on level ground with the handlebars turned so the top of the reservoir is level. If the fluid level is low, add DOT 3 brake fluid. **DO NOT OVERFILL.** See page 108 for the part numbers of Polaris products.

### **WARNING**

An over-full master cylinder may cause brake drag or brake lock-up, which could result in serious injury or death. Maintain brake fluid at the recommended level. Do not overfill.

### **WARNING**

After opening a bottle of brake fluid, always discard any unused portion. Never store or use a partial bottle. Brake fluid is hygroscopic, meaning it rapidly absorbs moisture from the air. The moisture causes the boiling temperature of the brake fluid to drop, which can lead to early brake fade and the possibility of accident or severe injury.



# FEATURES AND CONTROLS

## Brake Lever

The front and rear brakes are applied by squeezing the brake lever (1) toward the handlebar. The front and rear brakes are hydraulically activated disc type brakes that are activated by only one lever.

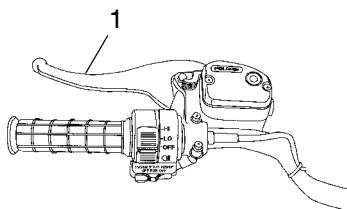

Always test brake lever travel and master cylinder fluid level before riding. When squeezed, the lever should feel firm. Any sponginess would indicate a possible fluid leak or low master cylinder fluid level, which must be corrected before riding. Contact your dealer for proper diagnosis and repairs.

### **WARNING**

Operating the ATV with a spongy brake lever can result in loss of braking, which could cause an accident.

Never operate the ATV with a spongy-feeling brake lever.

# FEATURES AND CONTROLS

## Parking Brake

### **⚠ WARNING**

Operating the ATV while the parking brake is engaged could result in an accident and serious injury or death. Always check to be sure the parking brake is disengaged before operating.

### Setting the Parking Brake

1. Squeeze and release the brake lever (1) two or three times, then squeeze and hold.
2. Push the park brake lock (2) forward to engage the brake. Release the brake lever.
3. To release the parking brake lock, squeeze and release the brake lever. It will return to its unlocked position.

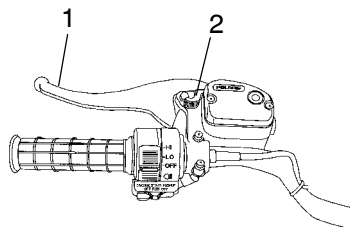

### Important Safeguards

- The parking brake may relax if left on for a long period of time. Always block the wheels to prevent rolling.
- Always block the wheels on the downhill side of the ATV if leaving it parked on a hill. Another option is to park the ATV in a sidehill position.
- Never depend on the parking brake alone if the ATV is parked on a hill. Always block the wheels to prevent rolling.

# FEATURES AND CONTROLS

## Auxiliary Brake

### WARNING

Aggressively applying the auxiliary brake when backing down a hill may cause rear tipover, which could result in serious injury or death.

Use caution when applying the auxiliary brake. Do not aggressively apply the auxiliary brake when going forward. The rear wheels may skid and slide sideways, causing loss of control and serious injury or death.

The auxiliary brake (1), is located on the inside of the right floor board and is operated by the right foot. The auxiliary brake serves as a backup to the main brake system if the main system becomes inoperative.

If the rear wheels slide while using the auxiliary brake, *reduce* brake pedal pressure to brake the rear wheels without skidding.

Check the brake fluid level frequently for the auxiliary brake system. The reservoir is located under the seat or near the foot brake. Maintain the fluid level between the maximum and minimum marks.

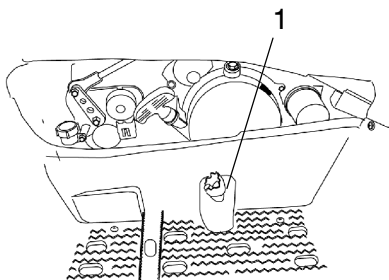

# FEATURES AND CONTROLS

## Choke

The choke assists in starting a cold engine. Refer to the engine starting procedure on page 52 for correct choke and throttle settings during starting.

## Fuel Valve

The fuel valve (1) is located on the left side of the vehicle on the side panel. It has three positions:

**OFF:** For vehicle storage and when transporting.

**ON:** For normal operation.

**RES:** For reserve supply if main supply is exhausted.

**NOTE:** There's about a 7 to 10 mile (11.2 to 16 km) range on reserve gas. Always refill the gas tank as soon as possible after using the reserve supply.

Always return valve to the *ON* position after refueling.

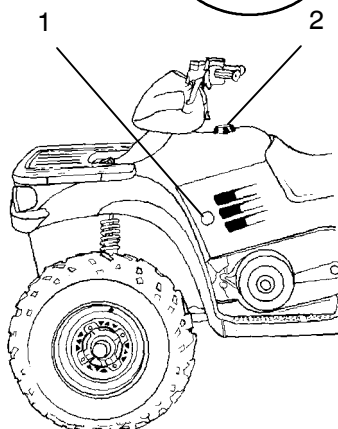
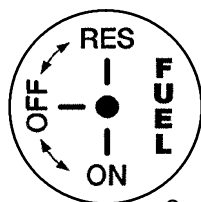

## Fuel Tank

The fuel tank filler cap (2) is located directly below the handlebar. Use either leaded or unleaded gasoline with a minimum pump octane number of  $87=(R+ M/2)$  octane. Refer to the specifications section beginning on page 109 for tank capacity.

## Fuel Filter

The in-line fuel filter should be replaced by your dealer after every 100 hours of operation, or annually. Do not attempt to clean the fuel filter.

# FEATURES AND CONTROLS

## Automatic Transmission Gear Selector

The transmission gear selector (1) is located on the right side of the vehicle.

H: High Gear  
N: Neutral  
L: Low Gear  
R: Reverse  
P: Park

To shift into HIGH or PARK, you must first apply the auxiliary brake to activate the high/park lock-out mechanism.

When shifting out of HIGH or PARK, it's not necessary to apply the brake.

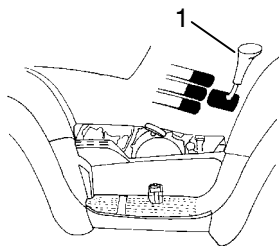
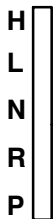

### CAUTION

Shifting gears with the engine speed above idle or while the vehicle is moving could cause transmission damage.

To change gears, stop the vehicle, and with the engine idling, move the lever to the desired gear. Apply the auxiliary brake if shifting into HIGH or PARK.

Whenever the ATV is left unattended, always place the transmission in PARK and lock the parking brake.

### Belt Life

To extend belt life, use low forward gear in heavy pulling situations and when operating at less than seven miles per hour for extended periods of time. If towing the vehicle is necessary, shift the transmission into neutral for better mobility and to prevent damage to the belt.

# FEATURES AND CONTROLS

## Recoil Starter

If the battery has been drained or damaged and cannot start the engine, use of the recoil starter (1) will allow vehicle operation until repairs can be made. The recoil starter is located on the right side of the machine.

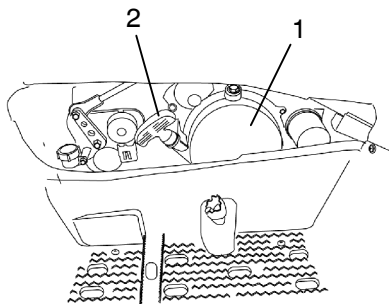

Polaris 4-cycle engines are equipped with automatic decompressors. This makes recoil starting possible by

reducing the amount of compression during starting. The decompressor senses when the engine is spinning fast enough to start and restores compression when running.

1. Position the vehicle on a level surface, place the transmission in PARK and lock the parking brake (see page 39).
2. Make sure the engine stop switch is set to *RUN* and the main key switch is in the ON position.

**NOTE:** If the engine is cold, use the choke as outlined on page 52.

3. Grasp the recoil starter rope handle (2) firmly and pull slowly so you can feel the engine strokes.

**NOTE:** Every other stroke will be a “compression stroke” and will make the rope harder to pull. When a compression stroke is found, continue pulling the rope just until the engine rolls past the stroke, then *stop pulling immediately*.

4. Allow the recoil rope to rewind into the recoil assembly, then pull the rope abruptly and forcefully to start the engine.
5. Repeat steps 3-4 if necessary.

## CAUTION

Extending the recoil starter rope until it stops can cause damage to the recoil assembly. Do not extend the starter rope so far that it stops.

If the starter rope handle is not seated properly, water may enter the recoil housing and damage components. Make sure the handle is fully seated on the recoil housing, especially when traveling in wet areas.

# FEATURES AND CONTROLS

## All Wheel Drive System (Domestic Models)

Polaris 4 wheel drive domestic model ATVs are equipped with a unique, Polaris exclusive, All Wheel Drive (AWD) System activated by a switch (1) on the right handlebar. Engage the AWD when the rear wheels lose traction.

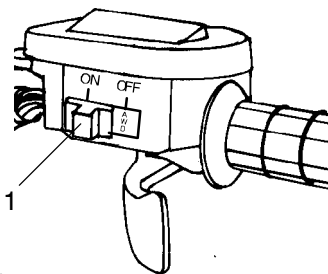

When the AWD switch is off, the ATV is in 2 wheel drive at all times. When the switch is on, the ATV is in AWD.

When in AWD, the front gearcase will automatically engage when the rear wheels lose traction. When the rear wheels regain traction, the front gearcase will automatically disengage.

**NOTE:** The override switch allows activation of AWD in reverse if the AWD switch is on. See page 34.

There is no limit to the length of time the vehicle may remain in AWD.

### Engaging Front Gearcase

The AWD switch may be turned on or off while the vehicle is moving. Initially, the vehicle's electronic system will not enable the AWD until the engine RPM is below 3100. Once enabled, the AWD remains enabled until the AWD switch is turned off. If the switch is turned off while the front gearcase is moving, it will not disengage until the rear wheels regain traction.

Engage the AWD switch before getting into conditions where front wheel drive may be needed. If the rear wheels are spinning, release the throttle before switching to AWD.

### CAUTION

Switching to AWD while the rear wheels are spinning may cause severe drive shaft and gearcase damage. Always switch to AWD while the rear wheels have traction or are at rest.

# FEATURES AND CONTROLS

## Instrument Cluster (Magnum 330)

Your ATV is equipped with an instrument cluster that senses vehicle speed from the right front wheel. The instrument cluster measures distance in miles as well as hours of operation. It also includes a reverse speed limiter function that limits the ATV's speed to approximately 7-9 mph (see page 34).

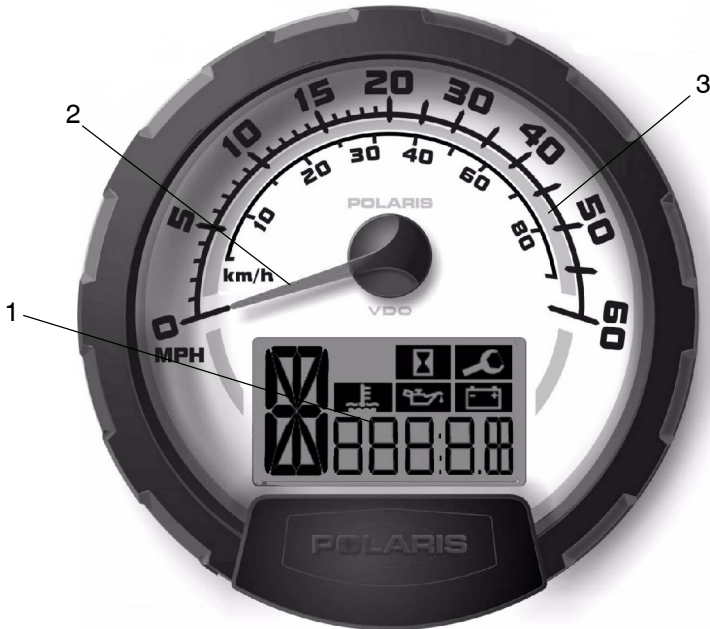

1. Rider Information Center
2. Speedometer needle - in addition to depicting vehicle speed, this needle will flash to signal a fault condition.
3. Speedometer

### CAUTION

Washing the ATV with a high pressure washer may cause water to enter the instrument cluster and cause damage to the electronic components. To prevent damage, wash the ATV by hand or with a garden hose using mild soap. Do not use alcohol to clean the instrument cluster. Immediately clean off any gasoline that splashes on the instrument cluster. Do not allow insect sprays to come into contact with the lens.



# FEATURES AND CONTROLS

## Instrument Cluster (Magnum 330)

### Rider Information Center

The rider information center is located in the lower portion of the instrument cluster.

1. Gear Indicator - As the shift lever is moved, this will indicate the gear the machine is in:

H = High Range

L = Low Range

N = Neutral

R = Reverse

P = Park

E or blank = Error - The error message usually means the gear selector is in between gears. It can, however, also indicate that the transmission switch needs repair.

2. High Engine Coolant Temperature - Do not continue to operate the ATV if this warning appears or serious engine damage could result.
3. Hour Meter
4. Service Interval/Miscellaneous Service Warnings
5. Low Battery and Over Voltage - This warning usually indicates that the ATV is being operated at an RPM too low to keep the battery charged. A low battery warning may also occur under normal operation if the machine is at idle and high electrical load (lights, cooling fan, accessories) is applied. Driving at a higher RPM or connecting a battery charger will usually clear the warning.

**NOTE:** If the instrument cluster no longer illuminates, it's possible that a battery over voltage occurred and the instrument cluster has shut off to protect the electrical system. If this occurs take the ATV to your Polaris dealer for proper diagnosis.

**NOTE:** All segments of the rider information center will light up for 2.5 seconds at start-up.

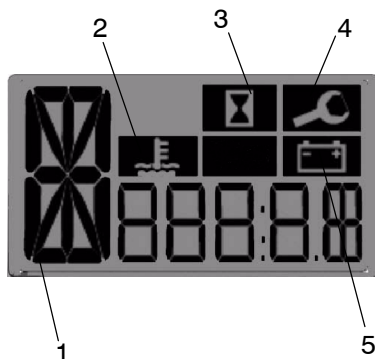

# FEATURES AND CONTROLS

## Instrument Cluster (Magnum 330)

### Rider Information Center

The rider information center has 4 standard modes:

Mode 1 - Odometer

Mode 2 - Tripmeter

Mode 3 - Total Service Hours

Mode 4 - Programmable service interval

The reverse override button on the left handlebar is also the *mode button*.

**NOTE:** If using the mode button to program the rider information center, or to toggle through the options, the machine cannot be in reverse.

### Mode 1 - Odometer

The odometer records the miles traveled by the ATV.

### Mode 2 -Trip Meter

The trip meter records the miles traveled by the ATV on each trip if it's reset before each trip. To reset the trip meter, select the trip meter mode. Press and hold the mode button (override button) until the total changes to 0.

**NOTE:** In the Rider Information Center, the trip meter display contains a decimal point, but the odometer displays without a decimal point.

### Mode 3 - Hour Meter

This mode logs the total hours the engine has been in operation.

# FEATURES AND CONTROLS

## Instrument Cluster (Magnum 330)

### Rider Information Center

#### Mode 4 - Programmable Service Interval

The purpose of the programmable service interval is to provide the consumer and dealer with a convenient reminder for routine maintenance. When your vehicle leaves the factory, this feature is turned off. You must enable the programmable service interval before it can be used.

Once the service interval mode is set with the hours when service is due, the hours of actual engine operation are subtracted from the set hours until 0 is reached. When the counter reaches 0, the wrench icon will flash quickly for 5 seconds each time the vehicle is started as a reminder that the periodic maintenance is due.

To set the hours, press and hold the mode/override button until the wrench icon flashes. When it begins to flash, release the button. The setting will increase by one hour each time the button is pressed. Pressing and holding the button will allow the numbers to escalate much faster. When the desired time increment is displayed, release the button and wait for the wrench to stop flashing. When the wrench stops blinking, your service hours are set.

**NOTE:** If you scroll past the intended number, hold the button down until the count turns over to 0. You can then reset the number.

If the service interval is enabled on your ATV and you wish to turn it off, toggle to the service interval mode. Press and hold the mode button for approximately 7 seconds until the word *OFF* appears in the Rider Information Center.

# FEATURES AND CONTROLS

## Instrument Cluster (Magnum 330)

### Rider Information Center

#### Diagnostic Mode

The diagnostic mode is for informational purposes only. Please return your ATV to your dealer for all major repairs.

To enter the diagnostics mode:

1. Turn the key switch off and wait 20 seconds.
2. Set the park brake and shift the transmission to neutral.
3. Hold the mode/reverse override button and turn the key switch on.

The initial screen displayed looks similar to the top illustration and refers to the software version installed in your ATV. This information is displayed briefly.

Use the mode/reverse override button to toggle through the diagnostic screens. The first screen (1) displays battery voltage.

Screen two (2) is the tachometer for setting idle speed. If this needs adjustment, please contact your dealer.

As long as the center is in the diagnostic mode, the wrench icon will remain lit.

To leave the diagnostic mode, either shift the machine out of neutral or turn the key switch off and on.



**NOTE:** Any movement of the tires will also take the machine out of the diagnostic mode.

# OPERATION

## Break-In Period

The break-in period for your new Polaris 4-cycle ATV is defined as the first ten hours of operation, or the time it takes to use the first two full tanks of gasoline. No single action on your part is as important as following the procedures for a proper break-in. Careful treatment of a new engine will result in more efficient performance and longer life for the engine. Perform the following procedures carefully.

### CAUTION

Excessive heat build-up during the first three hours of operation will damage close-fitted engine parts. Do not operate at full throttle or high speeds for extended periods during the first three hours of use.

### CAUTION

Mixing brands or using a non-recommended oil may cause serious engine damage. We recommend the use of Polaris Premium 4 synthetic Oil or another 0W-40 API certified *SH* oil. Never substitute or mix oil brands.

1. Fill the fuel tank with gasoline. See page 41.
2. Check the oil level on the dipstick. See page 75. Add Polaris Premium 4 Synthetic Oil if necessary to maintain the oil level in the normal/safe operating range (1).
3. Drive slowly at first. Select an open area that allows room to familiarize yourself with vehicle operation and handling.
4. Vary throttle positions. Do not operate at sustained idle.
5. Perform regular checks on fluid levels, controls and areas outlined on the daily pre-ride inspection checklist. See page 51.
6. Pull only light loads.
7. During the break-in period, change both the oil and the filter at 20 hours, 200 miles, or one month, whichever comes first.

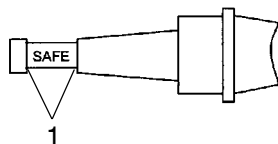

## Pre-Ride Inspection

### WARNING

If a proper inspection is not done before each use, severe injury or death could result. Always inspect the vehicle before each use to ensure it's in proper operating condition.

Pre-Ride Checklist		
Item	Remarks	See Page
Brake system / lever travel	Ensure proper operation	37, 38
Brake fluid	Ensure proper level	37
Auxiliary brake	Ensure proper operation	40
Front suspension	Inspect, lubricate if necessary	72
Rear suspension	Inspect, lubricate if necessary	72
Steering	Ensure free operation	-
Tires	Inspect condition and pressure	30,101
Wheels / fasteners	Inspect, ensure fastener tightness	100
Frame nuts, bolts, fasteners	Inspect, ensure tightness	-
Fuel and oil	Ensure proper levels	75
Coolant level (if applicable)	Ensure proper level	-
Coolant hoses (if applicable)	Inspect for leaks	-
Throttle	Ensure proper operation	36, 97
Indicator lights / switches	Ensure operation	34
Engine stop switch	Ensure proper operation	35
Air filter, pre-filter	Inspect, clean	102
Air box sediment tube	Drain deposits whenever visible	-
Headlamp	Check operation, apply dielectric grease when lamp is replaced	80
Brake light / tail lamp	Check operation, apply dielectric grease when lamp is replaced	81
Riding gear	Wear helmet, goggles, protective clothing	32

# OPERATION

## Starting the Engine

### Starting a Cold Engine

#### **WARNING**

Engine exhaust contains poisonous carbon monoxide and can cause loss of consciousness resulting in severe injury or death. Never run an engine in an enclosed area.

1. Place the transmission in PARK and lock the parking brake. Make sure the fuel valve is on.
2. Sit on the vehicle and pull the choke knob (1) out until it stops. If the knob doesn't stay where positioned, increase the tension by rotating the tension adjusting nut (2) clockwise.

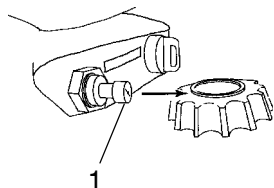

**NOTE:** The variable choke is fully on when the knob is pulled completely out. The choke is off when the knob is pushed completely in. The choke can be adjusted gradually, depending on how much choke is needed for starting. Be sure the choke is off during operation, as excess fuel washing into the engine oil will increase wear on engine components.

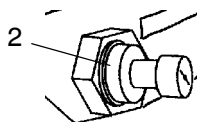

3. Move the engine stop switch to *RUN*.

**NOTE:** Do not press the throttle while starting the engine.

4. Turn the ignition key past the ON position to engage the starter for a maximum of five seconds. Release the key when the engine starts. If it doesn't start, release the key and wait five seconds. Activate the starter for another five seconds. Repeat until the engine starts.
5. If the engine slows or stops, position the choke knob half way in to allow proper engine warm up.
6. Vary the engine RPM slightly with the throttle to aid in warm-up. When the engine idles smoothly, push the choke all the way in.

#### **CAUTION**

Operating the vehicle immediately after starting could cause engine damage. Allow the engine to warm up for several minutes before operating the vehicle.

## Starting the Engine

### Starting a Warm Engine

Warm engines do not normally require the use of the choke. Excessive use of the choke can cause the spark plug to become wet fouled.

1. Position the vehicle on a level surface with the transmission in PARK.
2. Lock the parking brake, turn the fuel tank valve to *ON*, sit on the vehicle, and turn the engine stop switch to *RUN*.
3. If the engine has cooled to a point where it does not readily start, intermittent use of the choke button (pulled half way out) may be necessary.
4. If the engine is over-choked when warm, depress the throttle lever fully while cranking to aid in starting.
5. Release the throttle lever immediately after the engine starts. If the engine does not start and all conditions are favorable, change the spark plug and try again.

### Cold Weather Operation for 4-Cycle Engines

If the ATV is used year-round, check the oil level frequently. A rising oil level could indicate the accumulation of water in the bottom of the oil tank. Water in the bottom of the tank can lead to engine damage and must be drained. Water accumulation increases as outside temperature decreases.

See your Polaris dealer for engine heater kits, which provide quicker warm-ups and easier starting in colder weather.



# OPERATION

## Driving Safely

### Driving Procedures

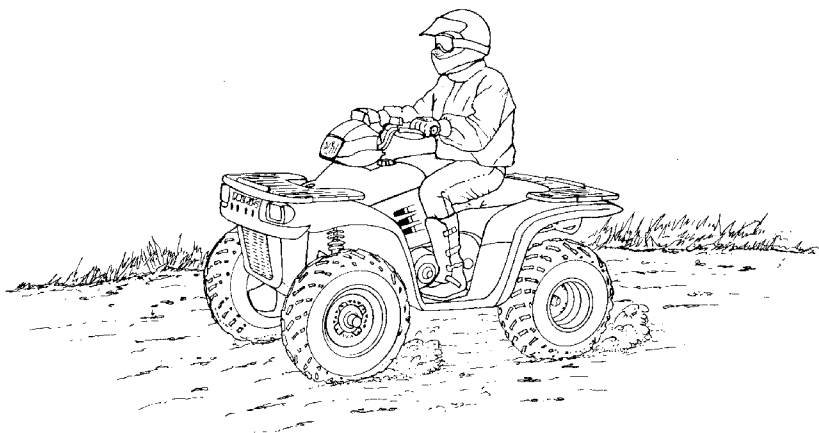

1. Sit upright with both feet on the footrests and both hands on the handlebars.
2. Start the engine and allow it to warm up, then shift the transmission into gear.
3. Check your surroundings and determine your path of travel.
4. Release the parking brake.
5. Slowly depress the throttle with your right thumb and begin driving. Vehicle speed is controlled by the amount of throttle opening.
6. Drive slowly. Practice maneuvering and using the throttle and brakes on level surfaces.

## Driving Safely Making Turns

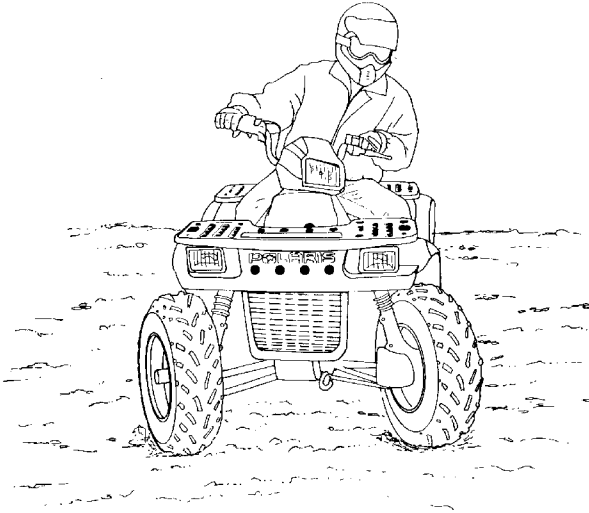

Your Polaris ATV is equipped with a solid rear axle that drives both rear wheels equally at all times. This means that the wheel on the outside of the turn must travel a greater distance than the inside wheel when turning and the inside tire must slip traction slightly.

To make a turn, steer in the direction of the turn, leaning your upper body to the inside of the turn while supporting your weight on the outer footrest. This technique alters the balance of traction between the rear wheels, allowing the turn to be made smoothly. The same leaning technique should be used for turning in reverse.

**NOTE:** Practice making turns at slow speeds before attempting to turn at faster speeds.

### **WARNING**

Turning at sharp angles or at excessive speeds can result in vehicle overturn and lead to serious injury. Avoid turning at sharp angles. Never turn at high speeds.

# OPERATION

## Driving Safely

### Hauling Cargo

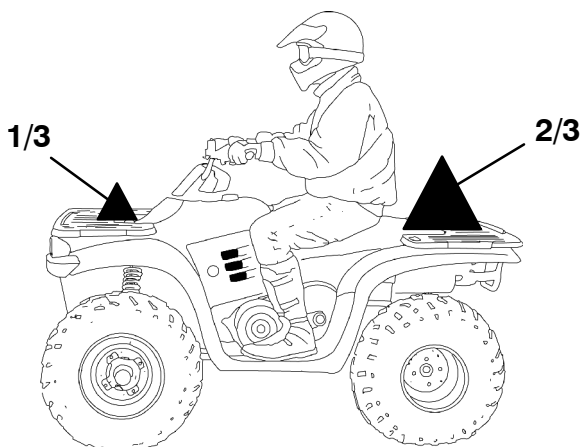

Your ATV has been designed to carry or tow a certain amount of load. Always read and understand the load distribution warnings listed on the warning labels, and never exceed the specified weights.

Cargo weight should be evenly distributed (1/3 on the front and 2/3 on the rear) and mounted as low as possible. When operating over rough or hilly terrain, reduce speed and cargo to maintain stable driving conditions.

#### **Belt Life**

Use low forward gear when hauling or towing heavy cargo to extend belt life.

## Driving Safely

### Hauling Cargo

#### **WARNING**

- **REDUCE SPEED AND ALLOW GREATER DISTANCES FOR BRAKING WHEN HAULING CARGO.**
- **CARGO WEIGHT DISTRIBUTION** should be 1/3 on the front rack and 2/3 on the rear rack. When operating over rough or hilly terrain, reduce speed and cargo to maintain stable driving conditions. Carrying loads on one rack only increases the possibility of vehicle overturn.
- **CARRY LOADS AS LOW ON THE RACKS AS POSSIBLE.** Carrying loads high on the racks raises the center of gravity of the vehicle and creates a less stable operating condition.
- **SECURE ALL LOADS BEFORE OPERATING.** Unsecured loads can create unstable operating conditions, which could result in loss of control of the vehicle.
- **OPERATE ONLY WITH STABLE AND SAFELY ARRANGED LOADS.** When handling off-centered loads that cannot be centered, securely fasten the load and operate with extra caution. Always attach the tow load to the hitch point designated for your vehicle.
- **HEAVY LOADS CAN CAUSE BRAKING AND CONTROL PROBLEMS.** Use extreme caution when applying brakes with a loaded vehicle. Avoid terrain or situations that may require backing downhill.
- **USE EXTREME CAUTION** when operating with loads that extend over the rack sides. Stability and maneuverability may be adversely affected, causing the vehicle to overturn.
- **DO NOT BLOCK THE FRONT HEADLIGHT BEAM** when carrying loads on the front rack.
- **DO NOT TRAVEL FASTER THAN THE RECOMMENDED SPEEDS.** Vehicle should never exceed 10 mph (16 kph) while towing a load on a level grass surface. Vehicle speed should never exceed 5 mph (8 kph) when towing loads in rough terrain, while cornering, or while ascending or descending a hill.

# OPERATION

## Driving Safely

### Driving on Slippery Surfaces

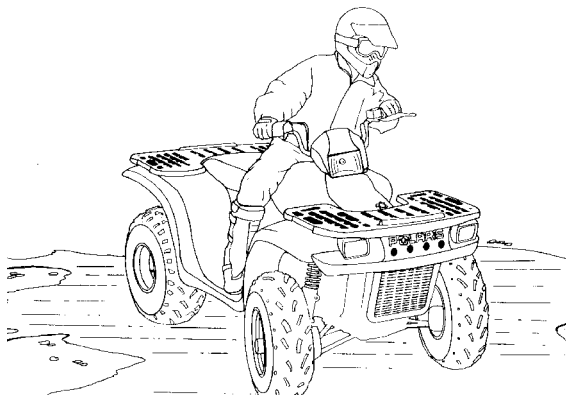

Whenever riding on slippery surfaces such as wet trails or loose gravel, or during freezing weather, follow these precautions:

1. Slow down when entering slippery areas.
2. Maintain a high level of alertness, reading the trail and avoiding quick, sharp turns which can cause skids.
3. Correct a skid by turning the handlebars in the direction of the skid and shifting your body weight forward.
4. Drive with AWD engaged (AWD models) to assist in controlling the vehicle in slippery areas.

## CAUTION

Severe damage to drive train may occur if the AWD is engaged while the wheels are spinning. Always allow the rear wheels to stop spinning before engaging AWD, or engage AWD before wheels begin to lose traction.



## WARNING

Failure to exercise care when operating on slippery surfaces can result in loss of tire traction and cause loss of control, accident, and serious injury or death.

Never apply the brakes during a skid. Do not operate on excessively slippery surfaces. Always reduce speed and use additional caution.

## Driving Safely

### Driving Uphill

Whenever traveling uphill, follow these precautions:

1. Always travel straight uphill.
2. Avoid steep hills (25° maximum).
3. Keep both feet on the footrests.
4. Transfer your weight forward.
5. Proceed at a steady rate of speed and throttle opening.
6. Remain alert and be prepared to take emergency action. This may include quick dismounting of the vehicle.

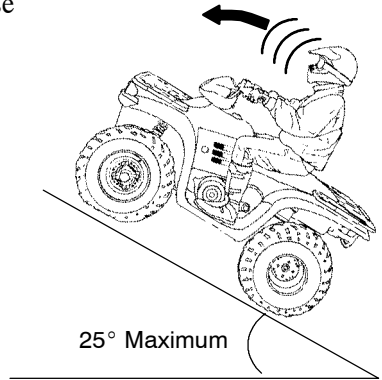

*If all forward speed is lost:*

Keep your weight uphill.

Apply the single lever brake, gradually. When fully stopped, apply the auxiliary brake as well, then lock the park brake.

*If the ATV begins rolling backwards:*

Keep your weight uphill. Never apply engine power. Never apply the auxiliary rear brake while rolling backwards.

Apply the single-lever brake, gradually. When fully stopped, apply the auxiliary rear brake as well, and then lock the parking brake.

Dismount on uphill side, or to either side if ATV is pointed straight uphill. Turn the ATV around and remount, following the procedure described on page 62.

## **⚠ WARNING**

Braking and handling are greatly affected when operating in hilly terrain. Improper procedure could cause loss of control or overturn and result in serious injury or death.

Avoid climbing steep hills (25° maximum).

Use extreme caution when operating on hills, and follow proper operating procedures outlined in the owner's manual.

# OPERATION

## Driving Safely

### Sidehilling



## **WARNING**

Improperly crossing hills or turning on hills can result in loss of control or vehicle overturn, resulting in severe injury or death. Avoid crossing the side of a hill when possible. Follow proper procedures as outlined in the owner's manual.

Sidehilling can be the most dangerous type of driving encountered and should be avoided if at all possible. If you do enter into a situation where sidehilling is necessary, follow these precautions:

1. Slow down.
2. Lean into the hill, transferring your upper body weight toward the hill while keeping your feet on the footrests.
3. Steer slightly into the hill to maintain vehicle directions.

**NOTE:** If the vehicle begins to tip, quickly turn the front wheel downhill, if possible, or dismount on the uphill side *immediately!*

## Driving Safely Driving Downhill



Whenever descending a hill, follow these precautions:

1. Proceed directly downhill.
2. Transfer your weight to the rear of the vehicle.
3. Slow down.
4. Apply the brakes *slightly* to aid in slowing, using the single brake lever.

**NOTE:** Familiarize yourself with operation of the auxiliary rear brake pedal for additional braking in the event of normal service brake loss.

### **⚠ WARNING**

Excessive speed can cause loss of control and lead to serious injury or death. Always operate slowly when traveling downhill.



# OPERATION

## Driving Safely

### Turning Around on a Hill

#### **⚠ WARNING**

Improper hill climbing procedures could cause loss of control or overturn and result in serious injury or death.

Avoid climbing steep hills (25° maximum).

Use extreme caution when operating on hills, and follow proper operating procedures outlined in the owner's manual.

If the vehicle stalls while climbing a hill, never back it down the hill! One maneuver that can be used when it's necessary to turn around while climbing a hill is the K-turn:

1. Stop and lock the parking brake while keeping body weight uphill.
2. Leave transmission in forward and shut off the engine.
3. Dismount on the uphill side of the vehicle, or on the left if the vehicle is pointing straight uphill.
4. Staying uphill of the vehicle, turn the handlebars full left.
5. While holding the brake lever, release the parking brake lock and slowly allow the vehicle to roll around to your right until it's pointing across the hill or slightly downward.
6. Lock the parking brake and remount the vehicle from the uphill side, keeping body weight uphill.
7. Restart the engine with the transmission still in forward.
8. Release the parking brake and proceed *slowly*, controlling speed with the brake, until the vehicle is on more level ground.

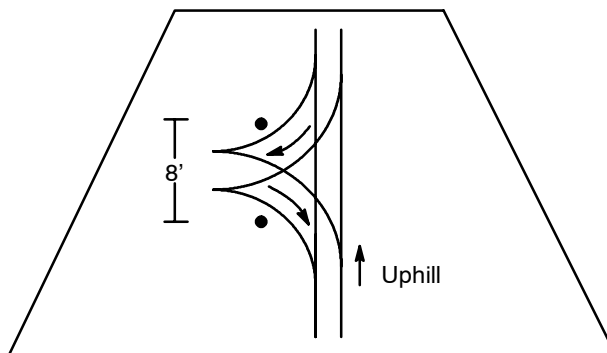

## Driving Safely

### Driving Through Water

Your ATV can operate through water with a maximum recommended depth equal to the bottom of the footrests (1). Follow these procedures when operating through water:



1. Determine water depths and current before crossing.
2. Choose a crossing where both banks have gradual inclines.
3. Proceed slowly, avoiding rocks and obstacles if possible.
4. After crossing, dry the brakes by applying light pressure to the lever until braking action is normal.

After running the vehicle in water, it's *critical* to have it serviced as outlined in the maintenance chart. See page 68. The following areas need special attention: engine oil, transmission oil, front and rear gearcases, and all grease fittings.

### CAUTION

Major engine damage can result if the vehicle is not thoroughly inspected after operation in water. Perform the services outlined in the maintenance chart.

If your vehicle becomes immersed or is operated in water that exceeds the footrest level, take it to your dealer for service before starting the engine.

**NOTE:** Avoid operating the vehicle through deep or fast-flowing water. If you cannot avoid water that exceeds the recommended maximum depth, go slowly, balance your weight carefully, avoid sudden movements, and maintain a slow and steady forward motion. Do not make sudden turns or stops, and do not make sudden throttle changes.

If your vehicle becomes immersed, and it's impossible to take it to a dealer before starting it, follow the steps described on page 83. Have the vehicle serviced by your dealer at the first opportunity.

# OPERATION

## Driving Safely

### Driving Over Obstacles

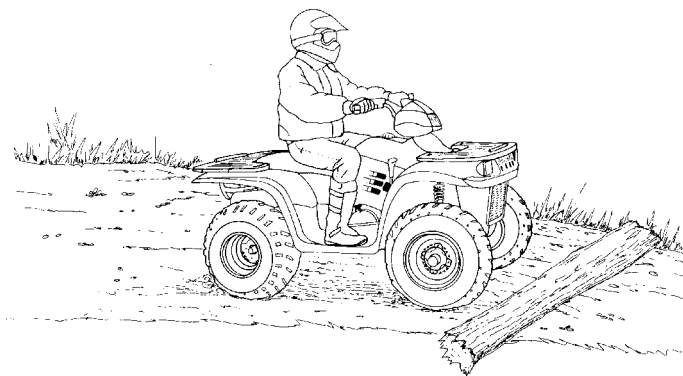

Be alert! Look ahead and learn to read the terrain you're traveling on. Be constantly alert for hazards such as logs, rocks and low hanging branches.

## **WARNING**

Severe injury or death can result if your vehicle comes in contact with a hidden obstacle. Not all obstacles are immediately visible. Travel with caution in unfamiliar terrain.

## Driving Safely

### Driving in Reverse

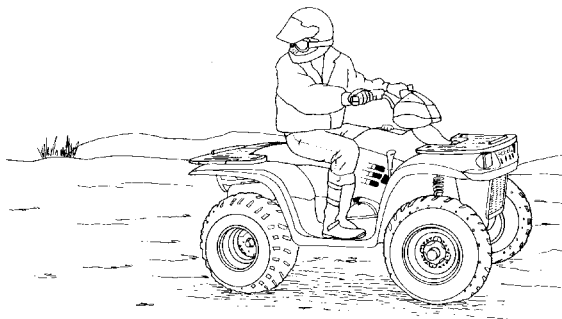

Follow these precautions when operating in reverse:

1. Always avoid backing downhill.
2. Back slowly.
3. When in reverse, apply the brakes *lightly* for stopping.
4. Avoid turning at sharp angles in reverse.
5. Never open the throttle suddenly while backing.

### **⚠ WARNING**

Failure to use caution when operating in reverse can result in serious injury or death. Before shifting into reverse, always check for obstacles or people behind the vehicle. When it's safe to proceed, back slowly.

Do not use the override switch unless additional power is required for vehicle movement. Use with caution.

Avoid backing on inclines, and avoid turning at sharp angles.

**NOTE:** Most Polaris ATVs are equipped with a reverse speed limiter. The override button should be used with caution as rearward vehicle speed is greatly increased. Do not operate at wide open throttle. Open the throttle just enough to maintain a desired speed.

### **CAUTION**

Excessive throttle operation while in the speed limit mode may cause fuel to build in the exhaust, resulting in engine popping and/or engine damage.

# OPERATION

## Driving Safely

### Parking on an Incline

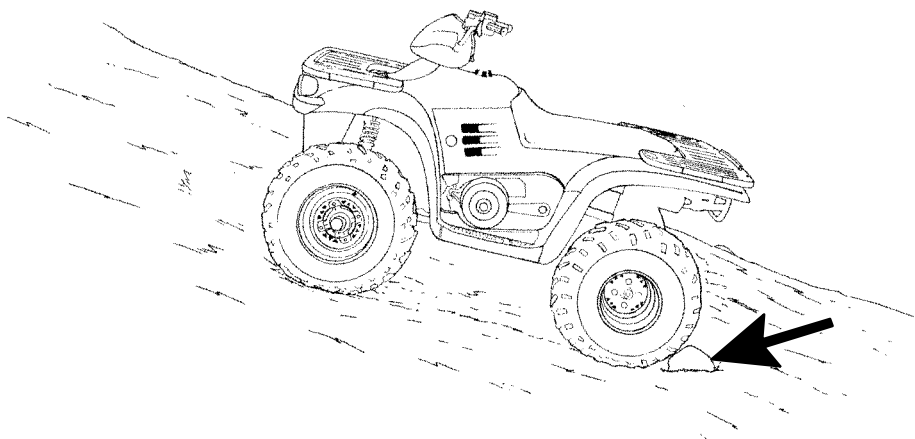

Avoid parking on an incline if possible. If it's unavoidable, follow these precautions:

1. Turn the engine off.
1. Place the transmission in PARK.
2. Set the parking brake.
3. Always block the rear wheels on the downhill side. See illustration.
4. Shut off the fuel supply.

# EMISSION CONTROL SYSTEMS

## Noise Emission Control System

Do not modify the engine, intake or exhaust components, as doing so may affect compliance with state and local noise level requirements.

## Crankcase Emission Control System

This engine is equipped with a closed crankcase system. Blow-by gases are forced back to the combustion chamber by the intake system. The system does not allow the blow-by gases to enter the atmosphere.

## Exhaust Emission Control System

The emissions from the exhaust of this vehicle are controlled by engine design, including factory-set fuel delivery and ignition. The engine and related components must be maintained at Polaris specifications to achieve optimal performance.

Adjustment to engine idle is the only adjustment Polaris recommends that the operator perform. Any other adjustments should be performed by an authorized Polaris dealer.

The emissions label (1) is located on the recoil cover.

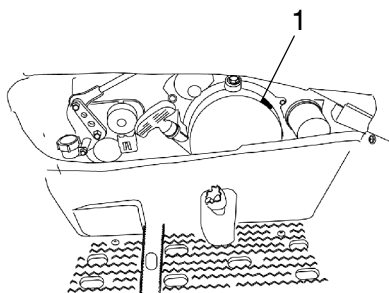

## **⚠** WARNING

The installation of devices that effectively increase exhaust emissions beyond their legal limits will void all manufacturer warranties and may violate laws governing the registration and operation of this vehicle.

## Spark Arrestor

Your Polaris vehicle has a spark arrestor that was tested and approved in accordance with the USDA Forest Service Standard 5100-1C. Federal law requires that this spark arrestor be installed and functional when the vehicle is operated on public lands.

## Electromagnetic Interference

This spark ignition system complies with Canadian ICES-002.

# MAINTENANCE AND LUBRICATION

## Periodic Maintenance Chart

Careful periodic maintenance will help keep your vehicle in the safest, most reliable condition. Inspection, adjustment and lubrication of important components are explained in the periodic maintenance chart.

Inspect, clean, lubricate, adjust and replace parts as necessary. When inspection reveals the need for replacement parts, use genuine Polaris parts available from your Polaris dealer.

**NOTE:** Service and adjustments are critical. If you're not familiar with safe service and adjustment procedures, have a qualified dealer perform these operations.

Some models are equipped with a speedometer that has a programmable service interval mode. This important feature will help you determine when maintenance service is due. See page 48 for instructions.

Maintenance intervals in the following charts are based upon average riding conditions and an average vehicle speed of approximately 10 miles per hour. Vehicles subjected to severe use must be inspected and serviced more frequently.

### Severe Use Definition

- Frequent immersion in mud, water or sand
- Racing or race-style high RPM use
- Prolonged low speed, heavy load operation
- Extended idle
- Short trip cold weather operation

### Maintenance Chart Key

- ▶ Perform these procedures more frequently for vehicles subjected to severe use.
- E Emission Control System Service (California)
- Have an authorized Polaris dealer perform these services.

### **WARNING**

Improperly performing the procedures marked with a ■ could result in component failure and lead to serious injury or death. Have an authorized Polaris dealer perform these services.

# MAINTENANCE AND LUBRICATION

## Periodic Maintenance Chart

Perform all services at whichever maintenance interval is reached first.

Item		Maintenance Interval (whichever comes first)			Remarks
		Hours	Calendar	Miles (Km)	
■	Steering	-	Pre-Ride	-	Make adjustments as needed. See Pre-Ride Checklist on page 51.
▶	Front suspension	-	Pre-Ride	-	
▶	Rear suspension	-	Pre-Ride	-	
	Tires	-	Pre-Ride	-	
▶	Brake fluid level	-	Pre-Ride	-	
▶	Brake lever travel	-	Pre-Ride	-	
	Brake system	-	Pre-Ride	-	
	Wheels/fasteners	-	Pre-Ride	-	
	Frame fasteners	-	Pre-Ride	-	
▶ E	Engine oil level	-	Pre-Ride	-	
▶ E	Air filter, pre-filter	-	Daily	-	
▶ E	Air box sediment tube	-	Daily	-	Drain deposits when visible
	Coolant (if applicable)	-	Daily	-	Check level daily, change coolant every 2 years
	Headlamp/tail lamp	-	Daily	-	Check operation; apply dielectric grease if replacing
▶ E	Air filter, main element	-	Weekly	-	Inspect; replace as needed
	Recoil housing	-	Weekly	-	Drain water as needed, check often if operating in wet conditions
▶ ■	Brake pad wear	10 H	Monthly	100 (160)	Inspect periodically
	Battery	20 H	Monthly	200 (320)	Check terminals; clean; test
▶	Front gearcase oil (if equipped)	25 H	Monthly	250 (400)	Inspect level; change yearly
▶	Rear gearcase oil (if equipped)	25 H	Monthly	250 (400)	Inspect level; change yearly
▶	Transmission oil	25 H	Monthly	250 (400)	Inspect level; change yearly
▶ E	Engine breather filter (if equipped)	25 H	Monthly	250 (400)	Inspect; clean if needed

▶ Perform these procedures more often for vehicles subjected to severe use.

E Emission Control System Service (California)

■ Have an authorized Polaris dealer perform these services.



# MAINTENANCE AND LUBRICATION

## Periodic Maintenance Chart

Item		Maintenance Interval (whichever comes first)			Remarks
		Hours	Calendar	Miles (Km)	
▶	General lubrication	50 H	3 M	500 (800)	Lubricate all fittings, pivots, cables, etc.
	Carburetor float bowl	50 H	6 M	500 (800)	Drain bowl periodically and prior to storage
■ E	Throttle Cable/ ETC Switch	50 H	6 M	500 (800)	Inspect; adjust; lubricate; replace if necessary
■ E	Choke cable	50 H	6 M	500 (800)	Inspect; adjust; lubricate; replace if necessary
E	Carburetor air intake ducts/ flange	50 H	6 M	500 (800)	Inspect ducts for proper sealing/air leaks
	Drive belt	50 H	6 M	500 (800)	Inspect; adjust; replace as needed
	Cooling system (if applicable)	50 H	6 M	1000 (1600)	Inspect coolant strength seasonally; pressure test system yearly
▶ E	Engine oil change	100 H	6 M	1000 (1600)	Perform a break-in oil change at one month
▶ E	Oil filter change	100 H	6 M	1000 (1600)	Replace with oil change
■ E	Valve clearance	100 H	12 M	1000 (1600)	Inspect; adjust
■ E	Fuel system/filter	100 H	12 M	1000 (1600)	Check for leaks at tank cap, lines, fuel valve, filter, pump, carburetor; replace lines every two years
▶	Radiator (if applicable)	100 H	12 M	1000 (1600)	Inspect; clean external surfaces
▶	Cooling hoses (if applicable)	100 H	12 M	1000 (1600)	Inspect for leaks
▶	Engine mounts	100 H	12 M	1000 (1600)	Inspect
	Exhaust muffler/ pipe	100 H	12 M	1000 (1600)	Inspect
■ E	Spark plug	100 H	12 M	1000 (1600)	Inspect; replace as needed
■ E	Ignition Timing	100 H	12 M	1000 (1600)	Inspect

▶ Perform these procedures more often for vehicles subjected to severe use.

E Emission Control System Service (California)

■ Have an authorized Polaris dealer perform these services.

# MAINTENANCE AND LUBRICATION

## Periodic Maintenance Chart

Item		Maintenance Interval (whichever comes first)			Remarks
		Hours	Calendar	Miles (Km)	
▶	Wiring	100 H	12 M	1000 (1600)	Inspect for wear, routing, security; apply dielectric grease to connectors subjected to water, mud, etc.
■	Clutches (drive and driven)	100 H	12 M	1000 (1600)	Inspect; clean; replace worn parts
■	Front wheel bearings	100 H	12 M	1000 (1600)	Inspect; replace as needed
■	Brake fluid	200 H	24 M	2000 (3200)	Change every two years
	Spark arrestor	300 H	36 M	3000 (4800)	Clean out
E	Idle speed	-			Adjust as needed
■	Toe adjustment	-			Inspect periodically; adjust when parts are replaced
	Headlight aim	-			Adjust as needed

▶ Perform these procedures more often for vehicles subjected to severe use.

E Emission Control System Service (California)

■ Have an authorized Polaris dealer perform these services.

# MAINTENANCE AND LUBRICATION

## Lubrication Guide

Check and lubricate all components at the intervals outlined in the Periodic Maintenance Chart beginning on page 68. Items not listed in the chart should be lubricated at the General Lubrication interval.

Item	Lube	Method
Engine Oil	Premium 4 Synthetic 0W40	See page 75.
Brakes	DOT 3 fluid only	See page 37.
(1) Transmission	Premium AGL Synthetic Gearcase Lube	See page 77.
(2) Front Gearcase	Premium Demand Drive Hub Fluid	See page 78.
(3) Rear Gearcase	Premium ATV Angle Drive Fluid	See page 79.
(4) Rear Prop Shaft	●Grease	Grease fitting (3 pumps maximum).
(5) Front Prop Shaft Yoke	●Grease	Grease fitting (3 pumps maximum).
(6) Ball Joint	▶★Grease	Locate fitting on back side of struts and grease with grease gun.

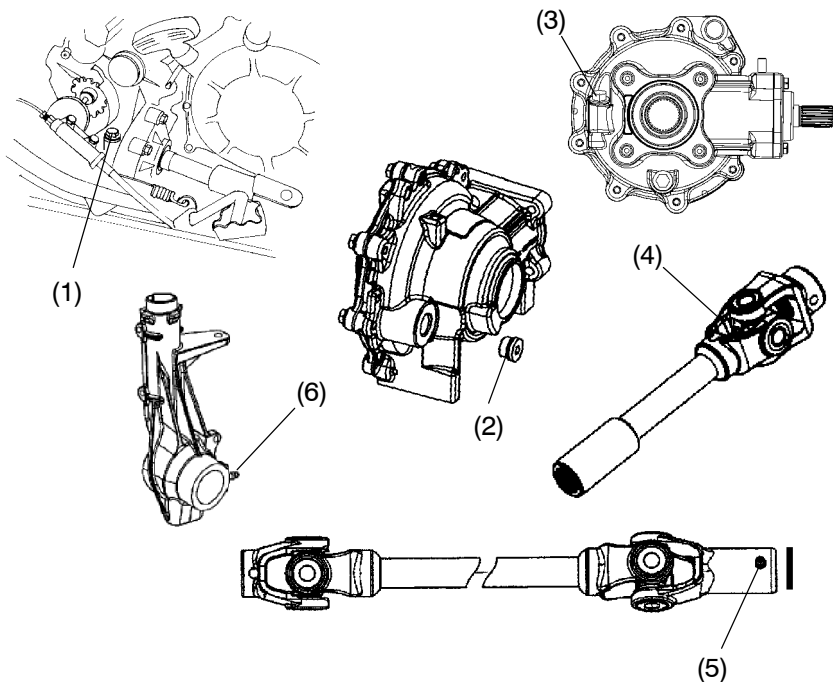

# MAINTENANCE AND LUBRICATION

## Periodic Maintenance Record

Use the following chart to record periodic maintenance.

<b>Maintenance Interval Performed</b>	<b>Servicing Date</b>	<b>Servicing Dealer or Person</b>	<b>Remarks</b>

# MAINTENANCE AND LUBRICATION

## Premium 4 Synthetic Lubricant

Polaris Premium 4 All Season synthetic engine oil has been specially formulated for use in Polaris 4-cycle engines. It's a fully synthetic, high performance, multi-viscosity oil designed to provide the ultimate in lubrication performance and protection.

**NOTE:** See page 108 for the part numbers of Polaris products.

Premium 4 possesses unsurpassed film strength over the widest possible temperature range. It resists viscosity and frictional breakdown in ambient temperatures from -40° F. to 120° F. (-40 to +49° C.) Its exceptional frictional properties result in more efficient operation, more power output and lower fuel consumption.

Although Polaris Premium 4 is the only oil recommended for use in this engine, use of any API certified *SH* oil is allowable as long as it's 0W-40. Oil may need to be changed more frequently if Polaris Premium 4 is not used. Follow the manufacturer's recommendations for ambient temperature operation.

### CAUTION

Mixing brands or using a non-recommended oil may cause serious engine damage. We recommend the use of Polaris Premium 4 synthetic Oil or another 0W-40 API certified *SH* oil. Never substitute or mix oil brands.

# MAINTENANCE AND LUBRICATION

## Engine Oil Check

The oil dipstick (1) is located on the left side of the engine.



**NOTE:** A rising oil level between checks in cool weather driving can indicate contaminants such as gas or moisture collecting in the crankcase. If the oil level is over the full/safe mark, change the oil immediately.

1. Position the ATV on a level surface.
2. Start the engine and let it idle for 20-30 seconds. Stop the engine.
3. Remove the dipstick and wipe it dry with a clean cloth.
4. Screw the dipstick completely in. The dipstick must be screwed completely in to ensure an accurate reading.
5. Remove the dipstick and read the oil level. Maintain the oil level in the normal/safe operating range (2). Do not overfill.

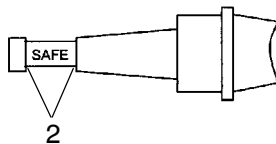

## Oil and Filter Change

### CAUTION

If the ATV is left without oil in the system for extended periods, the oil pump may lose its prime, which could result in engine damage. Always replace the oil and filter within a few hours of draining the oil. Do not allow the vehicle to be without oil overnight.

1. Obtain the correct oil filter and an adequate supply of oil so the oil and filter change can be completed without interruption.
2. Position the vehicle on a level surface.
3. Clean the area around the drain plug on the bottom of the engine crankcase.
4. Run the engine for two to three minutes until warm. Stop the engine.

### CAUTION

Hot oil can cause serious burns to skin. Do not allow hot oil to come into contact with skin.

# MAINTENANCE AND LUBRICATION

## Oil and Filter Change

5. Place a drain pan beneath the engine crankcase and remove the drain plug.
6. Allow the oil to drain completely.
7. Install a new sealing washer on the drain plug.

**NOTE:** The sealing surfaces on the drain plug and crankcase should be clean and free of burrs, nicks or scratches.

8. Reinstall the drain plug and torque to 14 ft. lbs. (19 Nm).
9. Place shop towels beneath the oil filter. Using an oil filter wrench, turn the filter counterclockwise to remove.
10. Using a clean, dry cloth, clean the filter sealing surface on the crankcase.
11. Lubricate the gasket on the new filter with a film of engine oil. Check to make sure the gasket is in good condition.
12. Install the new filter and turn by hand until the filter gasket contacts the sealing surface, then turn an additional 1/2 turn.
13. Remove the dipstick and fill the sump with the recommended oil. Refer to the specifications section beginning on page 109 for capacities.
14. Place the gear selector in PARK and lock the parking brake.
15. Start the engine and let it idle for one to two minutes. Stop the engine and inspect for leaks.
16. Recheck the oil level and add oil as necessary to bring the level to the upper mark on the dipstick.
17. Dispose of used filter and oil properly.

## Gearcase Specification Chart

Gearcase	Lubricant	Capacity	Fill Plug Torque	Drain Plug Torque
Transmission	Premium AGL Synthetic Gearcase Lubricant	13.5 oz. (400 ml)	14 ft. lbs. (19 Nm)	14 ft. lbs. (19 Nm)
Front Gearcase	Premium Demand Drive Hub Fluid	5 oz. (148 ml)	8-10 ft. lbs. (11-13 Nm)	11 ft. lbs. (15 Nm)
Rear Gearcase	Premium ATV Angle Drive Fluid	10 oz. (300 ml)	14 ft. lbs. (19 Nm)	14 ft. lbs. (19 Nm)

# MAINTENANCE AND LUBRICATION

## Transmission Oil

Always check and change the transmission oil at the intervals outlined in the Periodic Maintenance Chart beginning on page 68. Maintain the oil level  $1 \frac{5}{8}$ " from the top of the fill hole. We recommend the use of Premium AGL Synthetic Gearcase Lubricant. Refer to the gearcase specifications chart on page 76. See page 108 for the part numbers of Polaris products.

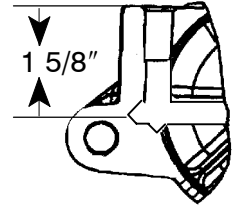

### Oil Check

The transmission fill plug (1), and check the oil level.

1. Position the ATV on a level surface.
2. Remove the fill plug (1), and check the oil level.
3. Add the recommended oil as needed.
4. Reinstall the fill plug. Torque to specification.

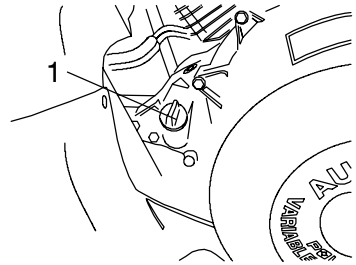

### Oil Change

The transmission drain plug is located on the bottom left hand side of the machine.

1. Remove the propshaft shield (if equipped) from the right side of the vehicle to access the fill plug.
2. Remove the fill plug.
3. Remove the transmission drain plug and drain the oil into an appropriate container. Discard used oil properly.
4. Clean and reinstall the drain plug. Torque to specification.
5. Add the recommended fluid.
6. Reinstall the fill plug. Torque to specification.
7. Check for leaks.
8. Reinstall the propshaft shield (if equipped).



# MAINTENANCE AND LUBRICATION

## Front Gearcase Oil

Always check and change the front gearcase oil at the intervals outlined in the Periodic Maintenance Chart beginning on page 68. Refer to the gearcase specifications chart on page 76. See page 108 for the part numbers of Polaris products.

### Oil Check

We recommend the use of Polaris Premium Demand Drive Hub Fluid in models with centralized Hilliard gearcases (domestic models). Maintain the level at the bottom of the fill plug threads (1).

1. Position the ATV on a level surface.
2. Remove the fill plug (2) and check the oil level.
3. Add the recommended oil as needed.
4. Reinstall the fill plug. Torque to specification.

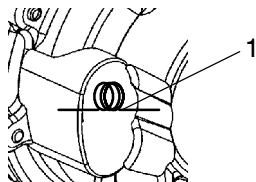

### Oil Change

1. Check the vent hose (3) to be sure it's unobstructed and routed properly.
2. Support the vehicle securely with a jackstand and remove the front tire on the driver's side.
3. Remove the drain plug (4) located on the bottom of the gearcase and drain the oil into a suitable container. The drain plug is accessible through the skid plate. Discard used oil properly.
4. Clean and reinstall drain plug using a new sealing washer. Torque to specification.
5. Remove the fill plug (3) and add the recommended fluid. **DO NOT OVERFILL.** Overfilling may cause excess drag, which can lead to unwanted engagement.
6. Reinstall the fill plug. Torque to specification.

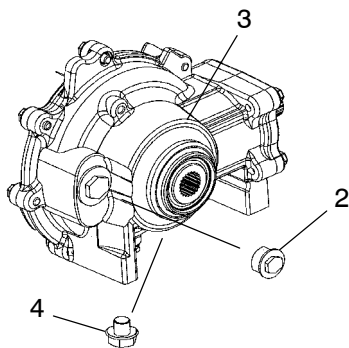

# MAINTENANCE AND LUBRICATION

## Rear Gearcase Oil

### Oil Check

Always check and change the rear gearcase oil at the intervals outlined in the Periodic Maintenance Chart beginning on page 68. Maintain the rear gearcase oil level at the bottom of the fill hole threads (1). We recommend the use of Polaris Premium ATV Angle Drive Fluid. Refer to the gearcase specifications chart on page 76. See page 108 for the part numbers of Polaris products.

1. Position the ATV on a level surface.
2. Remove the gearcase fill plug (2) and check the oil level.
3. Add the recommended oil as needed.
4. Reinstall the fill plug. Torque to specification.
5. Check for leaks.

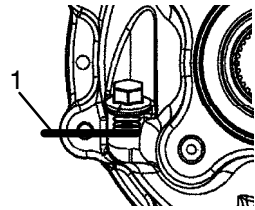
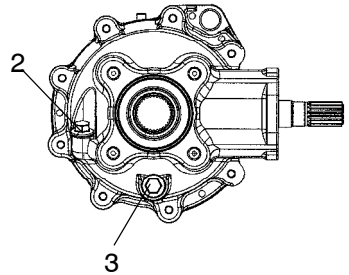

### Oil Change

1. Remove the drain plug (3) located on the bottom of the gearcase. Catch and discard the used oil properly.
2. Clean and reinstall the drain plug with a new sealing washer. Torque to specification.
3. Remove the fill plug and add the recommended gearcase oil.
4. Reinstall the fill plug. Torque to specification.
5. Check for leaks.

# MAINTENANCE AND LUBRICATION

## Lights

When servicing a halogen lamp, don't touch the lamp with bare fingers. Oil from your skin leaves a residue, causing a hot spot that will shorten the life of the lamp.

### **WARNING**

Poor lighting while driving can result in severe injury or death. Headlight and taillight lenses become dirty during normal operation. Wash the headlights frequently to maintain lighting quality.

Hot components can cause serious burns to skin. Do not service the headlamps until they've cooled sufficiently.

## Headlight Lamp Replacement

1. Turn the back of the headlight harness in a counter-clockwise direction to loosen (A).
2. Pull the harness assembly out from the headlight assembly.
3. Remove the headlamp and replace with a new headlamp.
4. Install the new headlamp and harness assembly into the headlight assembly. Turn the headlight harness clockwise (B) to secure.

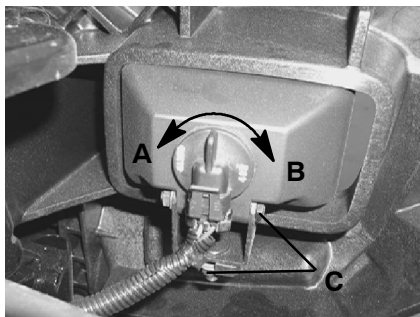

## Headlight Adjustment

1. Loosen the nuts (C) that secure the lower headlamps. Adjust the headlamps as needed.
2. Tighten the nuts.

# MAINTENANCE AND LUBRICATION

## Lights

### Taillight/Brakelight Lamp Replacement

If the taillight/brakelight does not work the lamp may need to be replaced.

1. Remove the taillight lens cover mounting screws. Remove the lens cover and gasket and set aside for reassembly.
2. Remove the lamp (1).
3. Apply dielectric grease to the socket and install a new bulb.
4. Test the taillight/brakelight for proper operation.
5. Reinstall the gasket and lens cover.

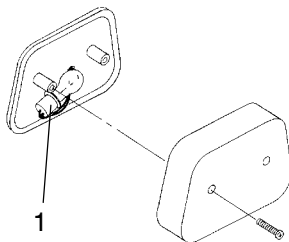

# MAINTENANCE AND LUBRICATION

## Spark Plugs

Refer to the specifications section beginning on page 109 for spark plug and gap specifications.

### CAUTION

Using non-recommended spark plugs can result in serious engine damage. Always use Polaris-recommended spark plugs.

Spark plug condition is indicative of engine operation. The spark plug firing end condition should be read after the engine has been warmed up and the vehicle has been driven at higher speeds. Immediately check the spark plug for correct color.

### ⚠ WARNING

A hot exhaust system and engine can cause serious burns. Wear protective gloves when removing a spark plug for inspection.

#### 1. Normal

The normal insulator tip is gray, tan or light brown. There will be few combustion deposits. The electrodes are not burned or eroded. This indicates the proper type and heat range for the engine and the service.

**NOTE:** The tip should not be white. A white insulator tip indicates overheating, caused by use of an improper spark plug or incorrect carburetion adjustments.

#### 2. Wet Fouled

The wet fouled insulator tip is black. A damp oil film covers the firing end. There may be a carbon layer over the entire nose. Generally, the electrodes are not worn. General causes of fouling are excessive oil, use of non-recommended injection oil, improper use of the choke, or incorrect carburetion adjustments.

### Spark Plug Removal and Replacement

1. Remove the spark plug cap.
2. Using the special wrench provided in the tool pouch, rotate the spark plug counterclockwise to remove.
3. Reverse the procedure for spark plug installation. Torque to 14 ft. lbs. (19 Nm).

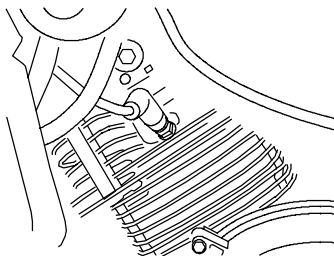

# MAINTENANCE AND LUBRICATION

## Vehicle Immersion

### CAUTION

If your vehicle becomes immersed, major engine damage can result if the machine is not thoroughly inspected. Take the vehicle to your dealer before starting the engine.

If it's impossible to take your ATV to a dealer before starting it, follow the steps outlined below.

1. Move the ATV to dry land or at the very least, to water below the footrests.
2. Check the airbox for any water and dry it if water is present.
3. Turn the fuel valve off.
4. Remove the spark plug.
5. Loosen the carburetor drain screw (1).
6. Turn the engine over several times using the electric start.
7. Dry the spark plug and reinstall, or replace it with a new plug.
8. Tighten the carburetor drain screw (1).
9. Turn the fuel valve on.
10. Attempt to start the engine. If necessary, repeat the drying procedure.
11. Take the ATV to your dealer for service as soon as possible, whether you succeed in starting it or not.

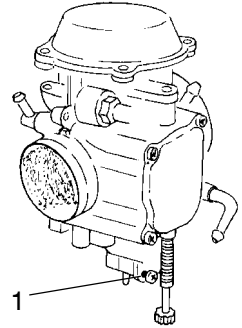

**NOTE:** If water has been ingested into the PVT, follow the procedure on page 87 for drying out the PVT.

# MAINTENANCE AND LUBRICATION

## Spark Arrestor

### **⚠ WARNING**

Failure to heed the following warnings while servicing the spark arrestor could result in serious injury or death.

Do not perform service on the spark arrestor while the system is hot. Exhaust system temperatures can reach 1000° F. Allow components to cool sufficiently before proceeding.

Remove any combustible materials from the area. Wear eye protection and leather work gloves. Do not stand behind or in front of the vehicle while purging. Never run the engine in an enclosed area. Exhaust contains poisonous carbon monoxide gas. Never go under the vehicle while it's inclined.

1. Remove the arrestor clean-out plug (1) from the bottom of the muffler.
2. Place the transmission in PARK and start the engine.
3. Purge carbon from the system by momentarily revving the engine several times.
4. If carbon is expelled, cover or plug the exhaust outlet (2) and rap on the pipe around the cleanout plug while revving the engine several more times.
5. If particles are still suspected to be in the muffler, elevate the rear of the vehicle one foot higher than the front. Set the parking brake and block the wheels. Make sure the vehicle is in PARK and repeat steps 3 and 4 until no more particles are expelled when the engine is revved.
6. Stop the engine and allow the arrestor to cool. Reinstall the arrestor plug and remove the outlet cover or plug.

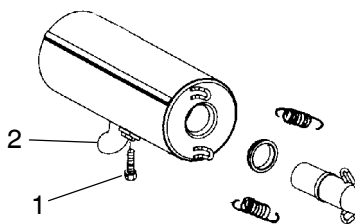

# MAINTENANCE AND LUBRICATION

## Recoil Housing

To prevent possible engine damage, always drain the recoil housing (1) after operating the ATV in very wet conditions. This should also be done before storing the ATV.

**NOTE:** Water will enter the recoil housing if the starter handle is disengaged from the rope guide when under water.

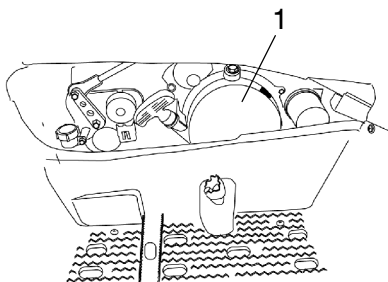

The drain screw is located at the bottom of the recoil housing. Use a wrench to remove the screw. Be sure to reinstall the screw after draining the housing.

**NOTE:** Do not open the *crankcase* drain unless the engine has ingested water. Some engine oil will be lost if crankcase drain is opened.



# MAINTENANCE AND LUBRICATION

## PVT System

The basic operation of the Polaris PVT system is dependent on engine speed and vehicle torque requirements. As engine speed increases, the force exerted on the movable drive sheave by the flyweights also increases. This, in turn, increases the amount of “pinch” applied to the drive belt. Similarly, if the engine speed decreases, the amount of centrifugal force decreases, reducing the amount of belt “pinch.”

On Polaris ATVs, the approximate gear ratio difference between high and low range is 1:2.25. This difference in gearing affects the operation of the PVT, especially at speeds less than 7 MPH, due to the system’s dependence on engine speed.

For example, when operating at a ground speed of 3 MPH in low range, the engine speed would be around 3000 RPM. This is well above the engagement speed of 1200 - 1400 RPM. However, in high range at 3 MPH, the engine would be running at only 1500 RPM. Whenever operating this close to the engagement speed, the engine may be running at a speed too low to provide the “pinch” needed to prevent belt slip. Belt slip is responsible for creating the excessive heat that destroys belts and causes outer clutch covers to fail.

By switching to low range while operating at low ground speeds, the air temperature in the clutch cover is reduced by almost 160 degrees. Reducing the temperature inside the clutch cover extends the life of the PVT components (belt, cover, etc.).

### When To Use Low Range vs. High Range

Following is a guideline for when to use low range and high range.

#### Low Range

- When basic operation is at speeds less than 7 MPH
- For heavy pulling
- When operating in rough terrain (swamps, mountains, etc.) at low ground speeds

#### High Range

- When basic operation is at speeds greater than 7 MPH
- When operating at high ground speeds

# MAINTENANCE AND LUBRICATION

## PVT System

### WARNING

Failure to comply with the instructions in this warning can result in severe injury or death.

Do not modify any component of the PVT system. Doing so may reduce its strength so that a failure may occur at a high speed. The PVT system has been precision balanced. Any modification will cause the system to be out of balance, creating vibration and additional loads on components.

The PVT system rotates at high speeds, creating large amounts of force on clutch components. Extensive engineering and testing has been conducted to ensure the safety of this product. However, as the owner, you have the following responsibilities to make sure this system remains safe:

Always follow all recommended maintenance procedures. See your dealer as outlined in the owner's manual.

This PVT system is intended for use on Polaris products only. Do not install it in any other product.

Always make sure the PVT housing is securely in place during operation.

### PVT Drying

There may be some instances when water is accidentally ingested into the PVT system. Use the following instructions to dry it out before operating:

1. Remove the drain plug and allow the water to drain. Replace the drain plug.
2. Start the engine and shift the transmission into PARK. Apply varying throttle for 10-15 seconds to expel the moisture and air-dry the belt and clutches. Do not hold the throttle wide open for more than 10 seconds.
3. Allow the engine RPM to settle to idle speed, then shift the transmission to the lowest available range.
4. Test for belt slippage. If the belt slips, repeat the process.
5. Take the vehicle to your dealer for service as soon as possible.

# MAINTENANCE AND LUBRICATION

## Battery

### **WARNING**

Improperly connecting or disconnecting battery cables can result in an explosion and cause serious injury or death. When removing the battery, always disconnect the negative (black) cable first. When reinstalling the battery, always connect the negative (black) cable last.

### **Battery Removal**

1. Disconnect the battery hold-down strap and remove the battery cover.
2. Disconnect the black (negative) battery cable first.
3. Disconnect the red (positive) battery cable next.
4. Lift the battery out of the ATV.

### **Battery Installation**

When installing a new battery, make sure it's fully charged prior to its initial use. Using a new battery that has not been fully charged can damage the battery and result in a shorter life. It can also hinder vehicle performance. Follow the battery charging instructions on page 89 before installing the battery.

1. Ensure that the battery is fully charged.
2. Set the battery in the battery holder.
3. Connect and tighten the red (positive) cable first.
4. Connect and tighten the black (negative) cable last.
5. Reinstall the battery cover and attach the hold-down strap.
6. Verify that cables are properly routed.

# MAINTENANCE AND LUBRICATION

## Battery

### Battery Storage

Whenever the vehicle is not used for a period of three months or more, remove the battery from the vehicle, ensure that it's fully charged, and store it out of the sun in a cool, dry place. Check battery voltage each month during storage and recharge as needed to maintain a full charge.

**NOTE:** Battery charge can be maintained by using a Polaris Battery Tender™ charger (PN 2871076) or by charging about once a month to make up for normal self-discharge. Battery Tender™ can be left connected during the storage period, and will automatically charge the battery if the voltage drops below a pre-determined point.

### Battery Charging

The following battery charging instructions apply only to the installation of a sealed battery. Read all instructions before proceeding with the installation of this battery.

The sealed battery is already filled with electrolyte and has been sealed and *fully charged* at the factory. *Never pry the sealing strip off or add any other fluid to this battery.*

The single most important thing about maintaining a sealed battery is to keep it fully charged. Since the battery is sealed and the sealing strip cannot be removed, you must use a voltmeter or multimeter to measure DC voltage.

For a refresh charge, follow all instructions carefully.

1. Check the battery voltage with a voltmeter or multimeter. A fully charged battery will register 12.8 V or higher.
2. If the voltage is less than 12.8 volts, recharge the battery at 1.2 amps or less until the battery voltage is 12.8 or greater.

**NOTE:** When using an automatic charger, refer to the charger manufacturer's instructions for recharging. When using a constant current charger, use the following guidelines for recharging.

## WARNING

An overheated battery may explode, causing severe injury or death. Always watch charging times carefully. Stop charging if the battery becomes very warm to the touch. Allow it to cool before resuming charging.

# MAINTENANCE AND LUBRICATION

## Battery

### Battery Charging

**NOTE:** Always verify battery condition before and 1-2 hours after the end of charging.

<b>State of Charge</b>	<b>Voltage</b>	<b>Action</b>	<b>Charge Time*</b> <small>(Using constant current charger @ standard amps specified on top of battery)</small>
100%	12.8-13.0 volts	None, check at 3 mos. from date of manufacture	None required
75%-100%	12.5-12.8 volts	May need slight charge, if no charge given, check in 3 months	3-6 hours
50%-75%	12.0-12.5 volts	Needs charge	5-11 hours
25%-50%	11.5-12.0 volts	Needs charge	At least 13 hours, verify state of charge
0%-25%	11.5 volts or less	Needs charge with desulfating charger	At least 20 hours

# MAINTENANCE AND LUBRICATION

## Adjustments

### Brakes

The front and rear brakes are hydraulic disc brakes, activated by moving the single brake lever toward the handlebar. These brakes are self-adjusting.

The following checks are recommended to keep the brake system in good operating condition. Check more often if brakes are used heavily under normal operation.

### **⚠ WARNING**

Never store or use a partial bottle of brake fluid. Brake fluid is hygroscopic, meaning it rapidly absorbs moisture from the air. The moisture causes the boiling temperature of the brake fluid to drop, which can lead to early brake fade and the possibility of accident or severe injury. After opening a bottle of brake fluid, always discard any unused portion.

### **⚠ WARNING**

An over-full master cylinder may cause brake drag or brake lock-up, which could result in serious injury or death. Maintain brake fluid at the recommended level. Do not overfill.

1. Always keep brake fluid at an adequate level (see page 37).

**NOTE:** Under normal operation, the diaphragm extends into the reservoir as fluid level drops. If the fluid level is low and the diaphragm is not extended, a leak is likely and the diaphragm should be replaced. Always fill the reservoir as needed whenever the cover is loosened or removed to ensure proper diaphragm operation. Use Polaris DOT 3 brake fluid. Do not overfill.

2. Check the brake system for fluid leaks.
3. Check the brakes for excessive travel or spongy feel.
4. Check the friction pads for wear, damage and looseness.
5. Check the security and surface condition of the disc.

**NOTE:** Change the brake pads when they're worn to 3/64" (.1 cm).

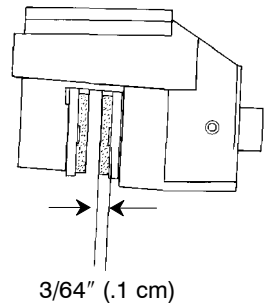

# MAINTENANCE AND LUBRICATION

## Adjustments

### Auxiliary Brake

The auxiliary brake is a hydraulic disc brake. The rear brake system is self-adjusting and requires no maintenance other than periodic checks of the pads for wear.

Change the brake pads when they're worn to  $3/64''$  (.1 cm).

Inspect the brake disc spline and pad wear surface for excessive wear.

Your vehicle's auxiliary brake system is intended to be used as a backup for the main brake system. Should the main system fail, the rear brake can be activated by depressing the foot pedal on the inside of the right footrest.

**NOTE:** Since the auxiliary brake is a rear brake only, it will not be as effective for braking as the all-wheel single lever system.

# MAINTENANCE AND LUBRICATION

## Adjustments

### WARNING

Severe injury or death can result from improper toe alignment and adjustment. Do not attempt to adjust tie rod alignment. All tie rod adjustments should be performed by an authorized Polaris dealer.

### Toe Alignment

Use the following procedure to check the toe alignment of the vehicle. The recommended toe alignment is 1/8" to 1/4" toe out.

1. Set the handlebars in a straight-ahead position.

**NOTE:** The steering frog can be used as an indicator of whether the handlebars are straight. The frog should always point straight back from the steering post.

2. Place stands (1) in front of the vehicle, perpendicular to the rear tires. See illustration.
3. Tie an elastic string around the stands, making sure the string just touches the side surface of the rear tires on each side of the vehicle and goes around the stands in front of the vehicle (2).
4. Measure the distance from the string to the rim at the front and rear of the front rim (3). Rear measurement should be 1/16" - 1/8" (.2 to .3 cm) more than the front measurement.

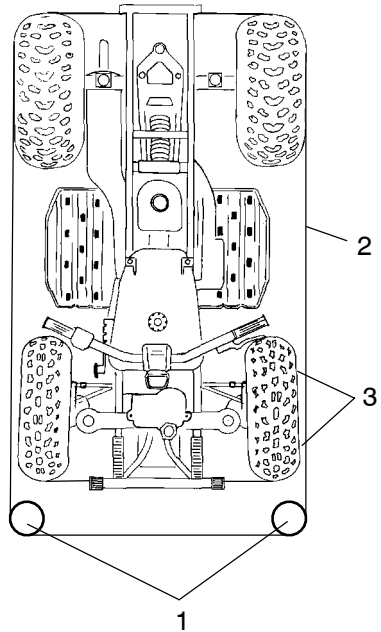

**NOTE:** If you discover improper alignment, see your Polaris dealer for service.



# MAINTENANCE AND LUBRICATION

## Adjustments

### Steering Assembly

The steering assembly of the ATV should be checked periodically for loose nuts and bolts. If loose nuts and bolts are found, see your Polaris dealer for service before operating the vehicle.

### Camber and Caster

The camber and caster are non-adjustable.

### Rear Spring

The rear shock absorber spring is adjusted by rotating the adjuster (1) either clockwise or counterclockwise to increase or decrease spring tension.

**NOTE:** Accessory springs are available through your Polaris dealer.

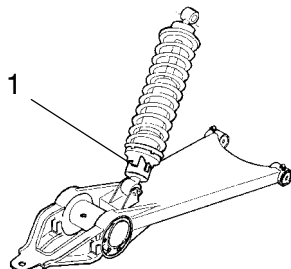

# MAINTENANCE AND LUBRICATION

## Adjustments

### **⚠ WARNING**

Improper adjustment of the handlebars or incorrect torquing of the adjuster block tightening bolts can cause limited steering or loosening of the handlebars, resulting in loss of control and possible serious personal injury or death. Follow the adjustment procedures exactly, or see your Polaris dealer for service.

### **Handlebars**

The handlebars can be adjusted for rider preference.

1. Remove the handlebar cover.
2. Loosen the four handlebar bolts (1).
3. Adjust the handlebar to the desired height. Be sure the handlebars do not contact the gas tank or any other part of the machine when turned fully to the left or right.
4. Torque the front two bolts to 10-12 ft. lbs. (14-17 Nm), then torque the rear two bolts. A gap of up to 1/8" will remain at the rear bolts.

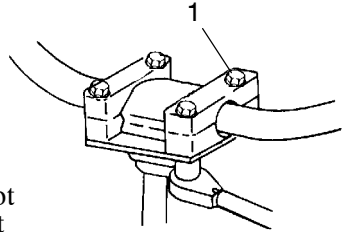

# MAINTENANCE AND LUBRICATION

## Adjustments

### Carburetor

**IMPORTANT:** Your Polaris ATV is calibrated at the factory for optimal performance at altitudes ranging from zero to 6,000 feet (1800 m) and temperatures of +40 degrees F. (4 degrees C.) or higher. Above 6000 feet (1800 m) the engine air/fuel mixture becomes overly rich and the engine loses approximately 3% of its power for each 1000-foot (304.8 m) increase in elevation. Although this power cannot be regained, adjustments to the carburetor and drive system can be made to allow more efficient operation. Optional jets, available from your Polaris dealer, are required for operation above 6,000 feet and temperatures below +40 degrees F. (4 degrees C.)

**NOTE:** Continuous operation of the engine without proper jetting when required can cause poor performance, overheating or engine damage. See your Polaris dealer for more information about jetting the ATV for conditions in your area.

If the engine idle speed is not satisfactory, and all other conditions are favorable, the carburetor can be adjusted.

1. Warm up the engine by running the vehicle for approximately five minutes.
2. Place the transmission in PARK and lock the parking brake.
3. Adjust the carburetor idle screw (1) either in or out until the desired idle RPM is reached. Turning the screw in (clockwise) will raise RPM. Turning the screw out (counterclockwise) will lower RPM.

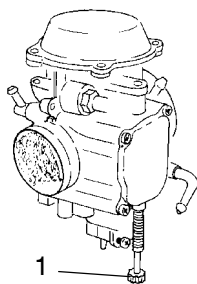

# MAINTENANCE AND LUBRICATION

## Adjustments

### Throttle Cable Freeplay

The throttle cable adjuster is located at the right handlebar.

1. Slide the boots (1) off the inline cable adjuster sleeve (2). Loosen the adjuster locknut (3).
2. Turn the adjuster until 1/16" to 1/8" freeplay is achieved at the thumb lever.

**NOTE:** While adjusting freeplay, be sure to flip the throttle lever back and forth.

3. Tighten the locknut and slide the boots over the cable adjuster until they touch at the midpoint of the adjuster.

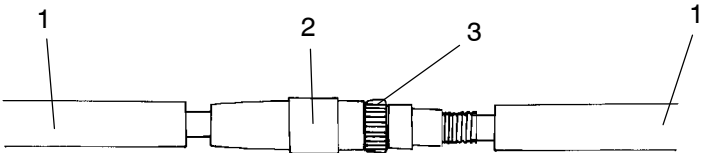

# MAINTENANCE AND LUBRICATION

## Adjustments

### Side Panel Removal

**NOTE:** Side panel removal may be difficult until the locking tabs and receivers have been snapped and unsnapped a few times.

1. Remove the seat.
2. Grasp the rear of the side panel near the rear cab. With a quick and firm motion, pull the panel forward and outward to disengage the two rear tabs.
3. Place your hand on top of the side panel behind the fuel tank. With a quick and firm motion, push down on the side panel to disengage the top rear two tabs. Then pull up on the side panel to disengage the front upper and lower tabs.
4. To reinstall the side panel, align the panel tabs with the slots on the front cab. Push the panel upward and forward until the tabs lock. Bend the rear of the side panel and insert the two tabs into the rear cab.

Step 2

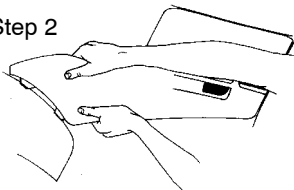

Step 3

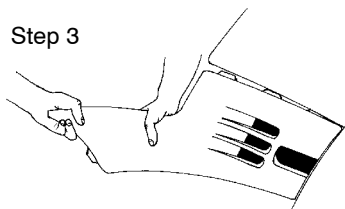

Step 4

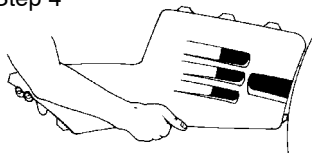

# MAINTENANCE AND LUBRICATION

## Adjustments

### **WARNING**

Operating your ATV with worn tires, improperly inflated tires, non-standard tires or improperly installed tires will affect vehicle handling and could cause an accident resulting in serious injury or death.

Maintain proper tire pressure as described on the decal on your ATV and in the specifications section of the owner's manual beginning on page 109.

Always use original equipment size and type when replacing tires.

Make sure the wheels are installed properly.

Always replace tires when the tread depth measures 1/8" (.3 cm) or less.

## Wheel Removal

1. Stop the engine, place the transmission in PARK and lock the parking brake.
2. Loosen the wheel nuts slightly.
3. Elevate the side of the vehicle by placing a suitable stand under the footrest frame.
4. Remove the wheel nuts and remove the wheel.

# MAINTENANCE AND LUBRICATION

## Adjustments

### **WARNING**

Improperly installed wheels can adversely affect tire wear and vehicle handling, which can result in serious injury or death. Always ensure that all nuts are torqued to specification. Do not service axle nuts that have a cotter pin installed. See your Polaris dealer.

### **Wheel Installation**

1. Place the transmission in PARK and lock the parking brake.
2. Place the wheel on the wheel hub with the valve stem toward the outside and rotation arrows on the tire pointing toward forward rotation.
3. Install the wheel nuts and finger tighten.
4. Lower the vehicle to the ground.
5. Torque the wheel nuts to specification.

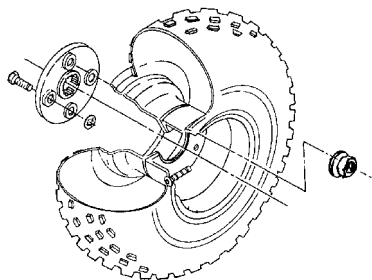

### **Wheel Nut Torque Specifications**

Check the wheel nut torques occasionally and when they've been loosened for maintenance service.

<b>Location</b>	<b>Specification</b>
Front Wheel Nuts	27 ft. lbs. (37 Nm)
Rear Wheel Nuts	27 ft. lbs. (37 Nm)

# MAINTENANCE AND LUBRICATION

## Adjustments

### Front Wheel Hub Tightening

Front wheel bearing tightness and spindle nut retention are critical component operations. All service must be performed by your authorized Polaris dealer.

### Tire Tread Depth

Always replace tires when tread depth is worn to 1/8" (.3 cm) or less. See illustration.

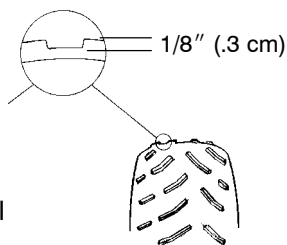

### **⚠ WARNING**

Operating the vehicle with worn tires will increase the possibility of skidding, which could lead to loss of control and serious injury or death. Always replace tires when the tread depth measures 1/8" (.3 cm) or less.

### **⚠ WARNING**

Use of non-standard size or type of tires or improper tire inflation may adversely affect vehicle maneuverability and cause loss of control resulting in serious injury or death. Maintain proper tire pressure as outlined in this owner's manual. When replacing a tire always use original equipment size and type.



# MAINTENANCE AND LUBRICATION

## Adjustments

### Air Filter Service

1. Remove the seat.
2. Release the clips and remove the air box cover (1).
3. Loosen the clamp and remove the filter.
4. Remove the fabric type pre-filter (2) from the main filter (3). Wash the pre-filter in soapy water, then rinse and let dry.
5. Reinstall the pre-filter over the main filter. (Replace the main filter if needed.)
6. Reinstall the filter into the air box and tighten the clamp. Do not over tighten the clamp, as filter damage could occur.

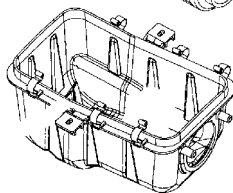
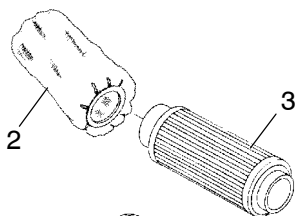
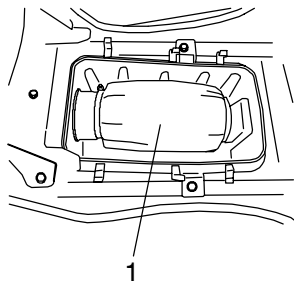

# MAINTENANCE AND LUBRICATION

## Accessories

Auxiliary power outlets provide 12V power for operating accessories such as hand held spot lights. See your Polaris dealer.

## Cleaning and Storage

See page 108 for the part numbers of Polaris products.

### Cleaning the ATV

Keeping your ATV clean will not only improve its appearance but it can also extend the life of various components. With a few precautions, your ATV can be cleaned much like an automobile.

### Washing the ATV

The best and safest way to clean your ATV is with a garden hose and a pail of mild soap and water. Use a professional type washing mitten, cleaning the upper body first and the lower parts last. Rinse with water frequently and dry with a chamois to prevent water spots.

**NOTE:** If warning and safety labels are damaged, contact your a Polaris dealer for free replacement.

Polaris does not recommend the use of a high pressure type car wash system for washing the ATV. If a high pressure system is used, exercise extreme care to avoid water damage to the wheel bearings, transmission seals, body panels, brakes and warning labels.

**NOTE:** Grease all zerk fittings immediately after washing, and allow the vehicle to run for a while to evaporate any water that may have entered the engine or exhaust system.

### Waxing the ATV

Your ATV can be waxed with any non-abrasive automotive paste wax. Avoid the use of harsh cleaners since they can scratch the body finish.

## CAUTION

Certain products, including insect repellants and chemicals, will damage plastic surfaces. Use caution when using these products near plastic surfaces.

# MAINTENANCE AND LUBRICATION

## Cleaning and Storage

### Storage Tips

See page 108 for the part numbers of Polaris products.

## CAUTION

Starting the engine during the storage period will disturb the protective film created by fogging and damage could occur. Never start the engine during the storage period.

### Exterior

Make necessary repairs and then clean the ATV thoroughly with mild soap and warm water to remove all dirt and grime. Don't use harsh detergents or high pressure washers. Some detergents deteriorate rubber parts. Use dish soap type cleaners only. High pressure washers may force water past seals.

### Fuel Stabilizer

Polaris Carbon Clean is a fuel stabilizer and fuel system dryer. It cleans the fuel system, the combustion chamber and the exhaust ports. It also prevents bacterial growth and promotes better starting after the storage period.

1. Fill the fuel tank with fuel and add Polaris Carbon Clean or Fuel Stabilizer. Follow the instructions on the container for the recommended amounts.
2. Start the engine and allow it to run for 15-20 minutes so the stabilizer can disperse through the fuel in the tank and carburetor.
3. Stop the engine, turn the fuel valve off, and drain the carburetor bowl.

### Oil and Filter

Warm the engine and change the oil and filter.

### Air Filter / Air Box

Inspect and clean or replace the pre-cleaner and air filter. Clean the air box and drain the sediment tube.

### Recoil Housing

Remove the recoil housing drain plug and drain any moisture.

### Engine Anti-Freeze

Test engine coolant strength and change if necessary. Coolant should be replaced every two years.

# MAINTENANCE AND LUBRICATION

## Cleaning and Storage

### Storage Tips

See page 108 for the part numbers of Polaris products.

### Fluid Levels

Inspect the following fluid levels and change if necessary: engine oil; transmission oil; brake fluid (change every two years or as needed if fluid looks dark or contaminated).

### Engine

1. Remove the spark plug and pour 2-3 tablespoons of Premium 4 Synthetic 0W40 engine oil into the hole. Use a section of clear 1/4" hose and a small plastic squeeze bottle filled with the pre-measured amount of oil.

**NOTE:** Do this carefully! If you miss the plug hole, oil will drain from the spark plug cavity into the hole at the front of the cylinder head and appear to be an oil leak.

2. Reinstall the spark plug.
3. With the ignition off, turn the engine over several times using the recoil starter. This will ensure coverage of the piston rings, cylinder walls and crankshaft bearings.
4. Apply dielectric grease to the inside of the spark plug cap and install the cap onto the plug.
5. Treat the fuel system with Polaris Carbon Clean.
6. If Polaris fuel system additive is not used, drain all fuel from the fuel tank, fuel lines, and carburetor. Eliminate any fuel remaining in the carburetor by running the engine until it stops.

### Lubricate

Inspect all cables and lubricate with Polaris Cable Lubricant. Follow lubrication guidelines in the maintenance section of the service or owner's manual to completely grease and lubricate the entire vehicle with Polaris Premium All Season Grease.

### Storage Area/Covers

Set the tire pressure and safely support the ATV with the tires 1-2" off the ground. Be sure the storage area is well ventilated, and cover the machine with a genuine Polaris ATV cover.

**NOTE:** Do not use plastic or coated materials. They do not allow enough ventilation to prevent condensation, and may promote corrosion and oxidation.

# **MAINTENANCE AND LUBRICATION**

## **Cleaning and Storage**

### **Chrome Wheel Care (if equipped)**

Proper maintenance will protect chrome wheels from corrosion, preserve wheel life and ensure a “like new” appearance for many years.

1. Wash chrome rims frequently. Use a mild detergent to remove any salt, dirt, mud or grime. Never use abrasive cleaners on plated or painted surfaces.
2. Polish the clean chrome wheels periodically. Use an automotive grade chrome polish.
3. Routinely and liberally apply a weather resistant wax to each polished chrome wheel. Choose a product suitable for chrome finishes. Read and follow the product labels and instructions.
4. Chrome wheels exposed to road salt (or salt in the air in coastal areas) are more susceptible to corrosion if not properly cleaned. Clean chrome wheels more often if they’re exposed to salt or other corrosive elements.

### **Removing Corrosion**

If light rust is found on the chrome finish, use steel wool (#0000-OTT grade) to remove it. Gently rub the affected areas with the steel wool until the corrosion has been removed. Clean and polish the wheel as outlined above.

# MAINTENANCE AND LUBRICATION

## Cleaning and Storage

### Transporting an ATV

Follow these procedures when transporting an ATV.

1. Turn off the engine and remove the key to prevent loss during transporting.
2. Turn the fuel valve off.
3. Be sure the fuel cap, oil cap and seat are installed correctly and securely.
4. Always tie the *frame* of the ATV to the transporting unit securely using suitable straps or rope. The rack, bumper or handlebars do not offer enough support for tie-down while transporting the unit.
5. Always place the transmission in PARK and lock the parking brake.

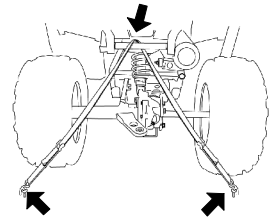
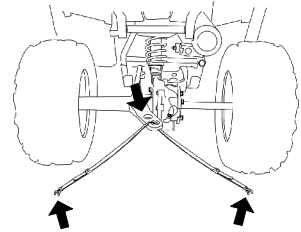
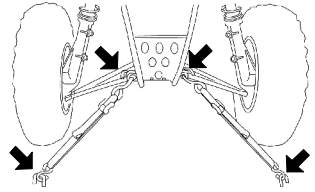

# POLARIS PRODUCTS

Part No.	Description
<b>Engine Lubricant</b>	
2870791	Fogging Oil (12 oz. Aerosol)
2871281	Premium 4 Synthetic 0W-40 (4-Cycle) Engine Oil (qt.)
2871844	Premium 4 Synthetic 0W-40 (4-Cycle) Engine Oil (gal.)
<b>Gearcase / Transmission Lubricants</b>	
2873602	Premium AGL Synthetic Gearcase Lube (qt.)
2873603	Premium AGL Synthetic Gearcase Lube (gal.)
2871653	Premium ATV Angle Drive Fluid (8 oz.)
2872276	Premium ATV Angle Drive Fluid (2.5 gal.)
2870465	Pump for Gallon Jug
2871654	Premium Demand Drive Hub Fluid (8 oz.)
2872277	Premium Demand Drive Hub Fluid (2.5 gal.)
<b>Grease / Specialized Lubricants</b>	
2871322	Premium All Season Grease (3 oz. cartridge)
2871423	Premium All Season Grease (14 oz. cartridge)
2871460	Starter Drive Grease
2871515	Premium U-Joint Lube (3 oz.)
2871551	Premium U-Joint Lube (14 oz.)
2871312	Grease Gun Kit
2871329	Dielectric Grease (Nyogel™)
2872073	Chain Lube (6.25 oz. aerosol)
2872348	Chain Lube (16 oz. aerosol)
<b>Coolant</b>	
2871323	60/40 Coolant (gal.)
2871534	60/40 Coolant (qt.)
<b>Additives / Miscellaneous</b>	
2872889	Brake and Clutch Cleaner
2871326	Carbon Clean Plus (12 oz.)
2870652	Fuel Stabilizer (16 oz.)
2870990	DOT3 Brake Fluid
2872893	Engine Degreaser
2871956	LOCTITE 565 Thread Sealant

# SPECIFICATIONS

## 2005 Magnum 330 2X4

<i>Capacities</i>	
Body Style	Gen IV
Gross Vehicle Weight	1060 lbs. (481 kg)
Fuel Capacity	3.2 gal. (12.1 l)
Engine Oil Capacity	1.9 qts. (1.8 l)
Transmission Oil	13.5 oz. (400 ml)
Rear Gearcase Oil	10 oz. (300 ml)
Front Rack	90 lbs. (40.8 kg)
Rear Rack	180 lbs. (81.6 kg)
Tongue Weight	100 lbs. (45.4 kg)(Rear rack weight and tongue weight not to exceed 180 lbs.)
Tow Capacity	1000 lbs.(454 kg)
Turn Radius	70 in. (178 cm) unloaded
Ground Clearance	6.75 in. (17.1 cm)
Length	81 in. (205.7 cm)
Width	46 in. (116.8 cm)
Height	46 in. (116.8 cm)
Seat Height	34 in. (86.4 cm)
Dry Weight	590 lbs. (268 kg)
Wheel Base	49.75 in. (126.4 cm)
<i>Engine &amp; Cooling</i>	
Engine Model Number / Type	ES32PFE103 / 4 Cycle, Single Cylinder
Lubrication	Wet Sump
Bore x Stroke	78.5 x 68
Displacement	329cc
Compression Ratio	9.2:1 Full Stroke
Engine Cooling	Air with fan assisted oil cooler
Alternator Output (watts)	200w @5000 rpm
Carburetion	1 / BST34 (CV Type)
Main Jet	122.5
Pilot Jet	42.5
Needle Jet	4HB48-3
Pilot Air Jet	160
Jet Needle	-2 Clip
Ignition	DC CDI
Timing	30° ± 2° @ 5000 RPM
Spark Plug Type / Gap	NGK BKR6E / .036 in. (.9 mm)



# SPECIFICATIONS

## 2005 Magnum 330 2X4

<i>Drive System</i>	
Drive System Type	PVT
Shift Type	Side Lever
Front Drive (ratio)	3.1/1
Front Tires	24 x 8-12 (4 psi)
Rear Tires	24 x 11-12 (3 psi)
<i>Suspension and Brakes</i>	
Front Suspension: Mac Strut	6.7 in. (17 cm) travel
Rear Suspension: Progressive Rate Swing Arm	7.1 in. (18 cm) travel
Shock Adjustment	CAM
Front Brake	Single-Control Hydraulic Disc
Rear Brake	Single-Control Hydraulic Disc
Auxiliary Brake	Hydraulic Disc
Park Brake	Hydraulic Lock, All Wheel
<i>Features</i>	
Headlight	Grill, Hi/Lo 30W
Taillight	12V 8.26W
Brake Light	12V 26.9W
Battery	12V 14 AH
DC Plug-In (Rear)	Accessory
Electric Start	Standard
High Beam Indicator	Standard
High Temp Indicator	Standard
Windshield	Accessory
Neutral Indicator	Standard
Reverse Indicator	Standard
Speedometer	Standard
Tool Kit	Standard

# SPECIFICATIONS

## 2005 Magnum 330 2X4

### Jetting Chart

Altitude	AMBIENT TEMPERATURE	Below 40° F (Below 5° C)	+40°F and above (+5°C and above)
Meters (Feet)	0-1800 (0-6000)	<b>127.5</b>	<b>122.5</b>
	1800-3700 (6000-12000)	<b>120</b>	<b>115</b>

### Clutching Chart

Altitude		Shift Weight	Drive Clutch Spring	Driven Clutch Spring	Helix/Spring Setting
Meters (Feet)	0-1800 (0-6000)	16 5630279	Blue/Green 7041157	Black 7041782	41-35° 5133701 2+2
	1800-3700 (6000-12000)	20-38 5631357	Blue/Green 7041157	Black 7041782	41-35° 5133701 2+2

# SPECIFICATIONS

## 2005 Magnum 330 4X4

<i>Capacities</i>	
Body Style	Gen IV
Gross Vehicle Weight	1100 lbs. (499 kg)
Fuel Capacity	3.25 gal. (12.3 l)
Engine Oil Capacity	1.9 qts. (1.8 l)
Transmission Oil	13.5 oz. (400 ml)
Front Gearcase Oil (Centralized Hilliard)	5 oz. (148 ml)
Rear Gearcase Oil	10 oz. (300 ml)
Front Rack	90 lbs. (40.8 kg)
Rear Rack	180 lbs. (81.6 kg)
Tongue Weight	100 lbs. (45.4 kg)(Rear rack weight and tongue weight not to exceed 180 lbs.)
Tow Capacity	1000 lbs.(454 kg)
Turn Radius	71 in. (180 cm) unloaded
Ground Clearance	6.75 in. (17.1 cm)
Length	81 in. (205.7 cm)
Width	46 in. (116.8 cm)
Height	46 in. (116.8 cm)
Seat Height	34 in. (86.4 cm)
Wheel Base	49.75 in. (126.4 cm)
Dry Weight	637 lbs. (289 kg)
<i>Engine &amp; Cooling</i>	
Engine Model Number / Type	ES32PFE103 / 4 Cycle, Single Cylinder
Lubrication	Wet Sump
Bore x Stroke	78.5 x 68
Displacement	329cc
Compression Ratio	9.2:1 Full Stroke
Engine Cooling	Air with fan assisted oil cooler
Alternator Output (watts)	200w @5000 rpm
Carburetion	1 / BST34 (CV Type)
Main Jet	122.5
Pilot Jet	42.5
Needle Jet	4HB48-3
Pilot Air Jet	160
Jet Needle	-2 Clip
Ignition	DC CDI
Timing	30° ± 2° @ 5000 RPM
Spark Plug Type / Gap	NGK BKR6E / .036 in. (.9 mm)

# SPECIFICATIONS

## 2005 Magnum 330 4X4

<i>Drive System</i>	
Drive System Type	PVT
Shift Type	Side Lever
Front Drive (ratio)	3.7/1
Final Drive (ratio)	3.1/1
Front Tires	24 x 8-12 (4 psi)
Rear Tires	24 x 11-12 (3 psi)
<i>Suspension and Brakes</i>	
Front Suspension: Mac Strut	6.7 in. (17 cm) travel
Rear Suspension: Progressive Rate Swing Arm	7.1 in. (18 cm) travel
Shock Adjustment	2 in. Gas Charged Monotube Cam
Front Brake	Single-Control Hydraulic Disc
Rear Brake	Single-Control Hydraulic Disc
Auxiliary Brake	Hydraulic Disc
Park Brake	Hydraulic Lock, All Wheel
<i>Features</i>	
Headlight	Grill, Hi/Lo 30W
Taillight	12V 8.26W
Brake Light	12V 26.9W
Battery	12V 14 AH
DC Plug-In (Rear)	Accessory
Electric Start	Standard
High Beam Indicator	Standard
High Temp Indicator	Standard
Windshield	Accessory
Neutral Indicator	Standard
Reverse Indicator	Standard
Speedometer	Standard
Tool Kit	Standard

# SPECIFICATIONS

## 2005 Magnum 330 4X4

### Jetting Chart

Altitude	AMBIENT TEMPERATURE	Below 40° F (Below 5° C)	+40°F and above (+5°C and above)
Meters (Feet)	0-1800 (0-6000)	<b>127.5</b>	<b>122.5</b>
	1800-3700 (6000-12000)	<b>120</b>	<b>115</b>

### Clutching Chart

Altitude		Shift Weight	Drive Clutch Spring	Driven Clutch Spring	Helix/Spring Setting
Meters (Feet)	0-1800 (0-6000)	16 5630279	Blue/Green 7041157	Black 7041782	41-35° 5133701 2+2
	1800-3700 (6000-12000)	20-38 5631357	Blue/Green 7041157	Black 7041782	41-35° 5133701 2+2

# TROUBLESHOOTING

## Drive Belt and Cover Problems

Possible Cause	Solution
Driving the ATV onto a pickup or tall trailer in high range.	Shift transmission to low range during loading of the ATV to prevent belt burning.
Starting out going up a steep incline.	When starting out on an incline, use low range or dismount the ATV (after first applying the park brake) and perform the K-turn as described on page 62.
Driving at low RPM or low ground speed (at approximately 3-7 MPH).	Drive at a higher speed or use low range more frequently. The use of low range is highly recommended for cooler PVT operating temperatures and longer component life.
Insufficient warm-up of ATVs exposed to low ambient temperatures.	Warm the engine at least 5 minutes. With the transmission in PARK, advance the throttle to about 1/8 throttle in short bursts, 5 to 7 times. The belt will become more flexible and prevent belt burning.
Slow and easy clutch engagement.	Use the throttle quickly and effectively for efficient engagement.
Towing/pushing at low RPM/low ground speed.	Use low range only.
Utility use/plowing snow, dirt, etc.	Use low range only.
Stuck in mud or snow.	Shift the transmission to low range, and carefully use fast, aggressive throttle application to engage clutch. <b>WARNING:</b> Excessive throttle may cause loss of control and vehicle overturn.
Climbing over large objects from a stopped position.	Shift the transmission to low range, and carefully use fast, brief, aggressive throttle application to engage clutch. <b>WARNING:</b> Excessive throttle may cause loss of control and vehicle overturn.
Belt slippage from water or snow ingestion into the PVT system.	Shift the transmission to PARK. Using the throttle, vary the engine RPM from idle to full throttle. Repeat several times as required. During this procedure, the throttle should not be held at the full position for more than 10 seconds. Clutch seals should be inspected for damage if repeated leaking occurs.
Clutch malfunction.	Contact your Polaris dealer for inspection of clutch components.
Poor engine performance.	Check for fouled plugs or foreign material in gas tank, fuel lines, or carburetor. Contact your dealer for service.

# TROUBLESHOOTING

Contact your Polaris dealer for service if you're unable to identify solutions using the following charts.

## Engine Doesn't Turn Over

Possible Cause	Solution
Tripped circuit breaker	Reset the breaker
Low battery voltage	Recharge battery to 12.8 VDC
Loose battery connections	Check all connections and tighten
Loose solenoid connections	Check all connections and tighten

## Engine Turns Over, Fails to Start

Possible Cause	Solution
Out of fuel	Turn fuel valve to reserve, refuel
Clogged fuel valve or filter	Inspect and clean or replace
Water is present in fuel	Drain the fuel system and refuel
Fuel valve is turned off	Turn the fuel valve on
Old or non-recommended fuel	Replace with new fuel
Fouled or defective spark plug(s)	Inspect plug(s), replace if necessary
No spark to spark plug	Inspect plug(s), verify stop switch is on
Crankcase filled with water or fuel	Immediately see your Polaris dealer
Overuse of choke	Inspect, clean and/or replace spark plugs
Clogged fuel filter	Replace the filter
Low battery voltage	Recharge battery to 12.8 VDC
Mechanical failure	See your Polaris dealer

## Engine Pings or Knocks

Possible Cause	Solution
Poor quality or low octane fuel	Replace with recommended fuel
Incorrect ignition timing	See your Polaris dealer
Incorrect spark plug gap or heat range	Set gap to specs or replace plugs

# TROUBLESHOOTING

## Engine Backfires

Possible Cause	Solution
Weak spark from spark plugs	Inspect, clean and/or replace spark plugs
Incorrect spark plug gap or heat range	Set gap to specs or replace plugs
Old or non-recommended fuel	Replace with new fuel
Incorrectly installed spark plug wires	See your Polaris dealer
Incorrect ignition timing	See your Polaris dealer
Mechanical failure	See your Polaris dealer

## Engine Runs Irregularly, Stalls or Misfires

Possible Weak Spark Cause	Solution
Fouled or defective spark plugs	Inspect, clean and/or replace spark plugs
Worn or defective spark plug wires	See your Polaris dealer
Incorrect spark plug gap or heat range	Set gap to specs or replace plugs
Loose ignition connections	Check all connections and tighten
Water present in fuel	Replace with new fuel
Low battery voltage	Recharge battery to 12.8 VDC
Kinked or plugged fuel vent line	Inspect and replace
Incorrect fuel	Replace with recommended fuel
Clogged air filter	Inspect and clean or replace
Reverse speed limiter malfunction	See your Polaris dealer
Electronic throttle control malfunction	See your Polaris dealer
Other mechanical failure	See your Polaris dealer

Possible Lean Fuel Mixture Cause	Solution
Low or contaminated fuel	Add or change fuel, clean the fuel system
Low octane fuel	Replace with recommended fuel
Clogged fuel filter	Replace filter
Incorrect jetting	See your Polaris dealer

Possible Rich Fuel Mixture Cause	Solution
Overuse of choke	Inspect, clean and/or replace spark plugs
Fuel is very high octane	Replace with lower octane fuel
Incorrect jetting	See your Polaris dealer



# TROUBLESHOOTING

## Engine Stops or Loses Power

Possible Cause	Solution
Out of fuel	Turn fuel valve to reserve, refuel
Kinked or plugged fuel vent line	Inspect and replace
Water present in fuel	Replace with new fuel
Overuse of choke	Inspect, clean and/or replace spark plugs
Fouled or defective spark plugs	Inspect, clean and/or replace spark plugs
Worn or defective spark plug wires	See your Polaris dealer
Incorrect spark plug gap or heat range	Set gap to specs or replace plugs
Loose ignition connections	Check all connections and tighten
Low battery voltage	Recharge battery to 12.8 VDC
Incorrect fuel	Replace with recommended fuel
Clogged air filter	Inspect and clean or replace
Reverse speed limiter malfunction	See your Polaris dealer
Electronic throttle control malfunction	See your Polaris dealer
Other mechanical failure	See your Polaris dealer
Overheated engine	Clean radiator screen and core if equipped Clean engine exterior See your Polaris dealer

# WARRANTY

## LIMITED WARRANTY

Polaris Sales Inc., 2100 Highway 55, Medina, MN 55340, gives a SIX MONTH LIMITED WARRANTY on all components of the Polaris All Terrain Vehicle (ATV) against defects in material or workmanship. Polaris also gives a one year limited warranty on the final drive chain for failure due to defects. This warranty covers the parts and labor charges for repair or replacement of defective parts which are covered by this warranty. This warranty begins on the date of purchase. This warranty is transferrable to another consumer during the warranty period through a Polaris dealer.

## REGISTRATION

At the time of sale, the Warranty Registration Form must be completed by your dealer and submitted to Polaris within ten days. Upon receipt of this registration, Polaris will record the registration for warranty. **THE PURCHASER MUST COMPLETE AN ATV SAFETY TRAINING COURSE PROVIDED BY THE DEALER IN ORDER TO HAVE VALID WARRANTY ON THE ATV.** No verification of registration will be sent to the purchaser as the copy of the Warranty Registration Form will be the warranty entitlement. If you have not signed the original registration and received the “customer copy”, please contact your dealer immediately. **NO WARRANTY COVERAGE WILL BE ALLOWED UNLESS YOUR ATV IS REGISTERED WITH POLARIS.**

Initial dealer preparation and set-up of your ATV is very important in ensuring trouble-free operation. Purchasing a machine in the crate or without proper dealer set-up will void your warranty coverage.

## WARRANTY COVERAGE AND EXCLUSIONS:

### LIMITATIONS OF WARRANTIES AND REMEDIES

The Polaris limited warranty excludes any failures that are not caused by a defect in material or workmanship. This warranty does not cover accidental damage, normal wear and tear, abuse or improper handling. This warranty also does not cover any ATV that has been altered structurally, modified, neglected, improperly maintained, used for racing, or used for purposes other than for which it was manufactured, or for any damages which occur during trailer transit or as a result of unauthorized service or the use of unauthorized parts. In addition, this warranty does not cover physical damage to paint or finish, stress cracks, tearing or puncturing of upholstery material, corrosion, or defects in parts, components or the ATV due to fire, explosions or any other cause beyond Polaris' control.

This warranty does not cover the use of unauthorized lubricants, chemicals, or fuels that are not compatible with the ATV. The exclusive remedy for breach of this warranty shall be, at Polaris' exclusive option, repair or replacement of any defective materials, or components or products. **THE REMEDIES SET FORTH IN THIS WARRANTY ARE THE ONLY REMEDIES AVAILABLE TO ANY PERSON FOR BREACH OF THIS WARRANTY. POLARIS SHALL HAVE NO LIABILITY TO ANY PERSON FOR INCIDENTAL, CONSEQUENTIAL OR SPECIAL DAMAGES OF ANY DESCRIPTION, WHETHER ARISING OUT OF EXPRESS OR IMPLIED WARRANTY OR ANY OTHER CONTRACT, NEGLIGENCE, OR OTHER TORT OR OTHERWISE.** Some states do not permit the exclusion or limitation of incidental or consequential damages or implied warranties, so the above limitations or exclusions may not apply to you if inconsistent with controlling state law.

# WARRANTY

## WARRANTY COVERAGE AND EXCLUSIONS:

### LIMITATIONS OF WARRANTIES AND REMEDIES

ALL IMPLIED WARRANTIES (INCLUDING BUT NOT LIMITED TO THE IMPLIED WARRANTIES OF MERCHANTABILITY AND FITNESS FOR A PARTICULAR PURPOSE) ARE LIMITED IN DURATION TO THE ABOVE SIX MONTH WARRANTY PERIOD. POLARIS FURTHER DISCLAIMS ALL EXPRESS WARRANTIES NOT STATED IN THIS WARRANTY. Some states do not allow limitations on how long an implied warranty lasts, so the above limitation may not apply to you if inconsistent with controlling state law.

### HOW TO OBTAIN WARRANTY SERVICE

If your ATV requires warranty service, you must take it to a Polaris dealer authorized to repair Polaris ATVs. When requesting warranty service you must present your copy of the Warranty Registration form to the dealer. (THE COST OF TRANSPORTATION TO AND FROM THE DEALER IS YOUR RESPONSIBILITY). Polaris suggests that you use your original selling dealer; however, you may use any Polaris Servicing Dealer to perform warranty service.

Please work with your dealer to resolve any warranty issues. Should your dealer require any additional assistance they will contact the appropriate personnel at Polaris.

This warranty gives you specific legal rights, and you may also have other rights which vary from state to state.

If any of the above terms are void because of state or federal law, all other warranty terms will remain in effect.

### Engine Oil

1. Mixing oil brands or using non-recommended oil may cause engine damage. We recommend the use of Polaris engine oil.
2. Damage resulting from the use of non-recommended lubricants may not be covered by warranty.

# WARRANTY

## Exported Vehicles

EXCEPT WHERE SPECIFICALLY REQUIRED BY LAW, THERE IS NO WARRANTY OR SERVICE BULLETIN COVERAGE ON THIS VEHICLE IF IT IS SOLD OUTSIDE THE COUNTRY OF THE SELLING DEALER'S AUTHORIZED LOCATION.

This policy does not apply to vehicles that have received authorization for export from Polaris Industries. Dealers may not give authorization for export. You should consult an authorized dealer to determine this vehicle's warranty or service bulletin coverage if you have any questions.

This policy does not apply to vehicles registered to government officials or military personnel on assignment outside the country of the selling dealer's authorized location.

This policy does not apply to Safety Recalls.

## How to Get Service

### *In the Country where your vehicle was purchased:*

Warranty or Service Bulletin repairs must be done by an authorized Polaris dealer. If you move or are traveling within the country where your vehicle was purchased, Warranty or Service Bulletin repairs may be requested from any authorized Polaris dealer who sells the same line as your vehicle.

### *Outside the Country where your vehicle was purchased:*

If you are traveling temporarily outside the country where your vehicle was purchased, you should take your vehicle to an authorized Polaris dealer. You must show the dealer photo identification from the country of the selling dealer's authorized location as proof of residence. Upon residence verification, the servicing dealer will be authorized to perform the warranty repair.

### *If You Move:*

If you move to another country, be sure to contact Polaris Customer Assistance and the customs department of the destination country before you move. Vehicles importation rules vary considerably from country to country. You may be required to present documentation of your move to Polaris Industries in order to continue your warranty coverage. You may also be required to obtain documentation from Polaris Industries in order to register your vehicle in your new country.

## How to Get Service

### *If Purchased From A Private Party:*

If you purchase a Polaris product from a private citizen outside of the country in which the vehicle was originally purchased, all warranty coverage will be denied.

## Notice

If your vehicle is registered outside of the country where it was purchased, and you have not followed the procedure set out above, your vehicle will no longer be eligible for warranty or service bulletin coverage of any kind. (Vehicles registered to Government officials or military personnel on assignment outside of the country where the vehicle was purchased will continue to be covered by the basic warranty.)

### *For questions call Polaris Customer Assistance:*

United States: 1-763-417-8650

Canada: 1-204-925-7100

# INDEX

## A

Accessories . . . . .	103
Adjustments . . . . .	91-102
Age Restrictions . . . . .	8
Air Filter . . . . .	102
All Wheel Drive . . . . .	44
All Wheel Drive Switch . . . . .	35
Auxiliary Brake . . . . .	40, 92
AWD Switch . . . . .	35

## B

Battery . . . . .	88-90
Battery Charging . . . . .	89-90
Battery Installation . . . . .	88
Battery Removal . . . . .	88
Battery Storage . . . . .	89
Belt Life . . . . .	42
Brake Lever . . . . .	38
Brakes . . . . .	37, 91
Break-In Period . . . . .	50

## C

Camber and Caster . . . . .	94
Carburetor . . . . .	96
Choke . . . . .	41
Chrome Wheel Care . . . . .	106
Cleaning and Storage . . . . .	103-107
Cleaning the ATV . . . . .	103
Clutching Chart, 2X4 . . . . .	111
Clutching Chart, 4X4 . . . . .	114
Cold Weather Operation . . . . .	53
CONTROLS . . . . .	34-49
Corrosion . . . . .	106
Crankcase Emission Control System . . . . .	67

## D

Diagnostic Mode . . . . .	49
Driving Downhill . . . . .	61
Driving in Reverse . . . . .	65
Driving on Slippery Surfaces . . . . .	58
Driving Over Obstacles . . . . .	64
Driving Procedures . . . . .	54
Driving Safely . . . . .	54-66
Driving Through Water . . . . .	63
Driving Uphill . . . . .	59

## E

Electrical Switches . . . . .	34-35
Electromagnetic Interference . . . . .	67
EMISSION CONTROL SYSTEMS . . . . .	67
Engaging Front Gearcase . . . . .	44
Engine Fogging . . . . .	105
Equipment Modifications . . . . .	12
Exhaust Emission Control System . . . . .	67

## F

FEATURES . . . . .	34-49
Front Gearcase Oil . . . . .	78
Front Wheel Hub Tightening . . . . .	101
Fuel Filter . . . . .	41
Fuel Safety . . . . .	33
Fuel Stabilizer . . . . .	104
Fuel Tank . . . . .	41
Fuel Valve . . . . .	41

## G

Gear Selector . . . . .	42
Gearcase Oil, Front . . . . .	78
Gearcase Oil, Rear . . . . .	79
Gearcase Specification Chart . . . . .	76

## H

Handlebars . . . . .	95
Hauling Cargo . . . . .	56-57
Headlight Adjustment . . . . .	80
Headlight Lamp Replacement . . . . .	80
Helmet . . . . .	32
High Range . . . . .	86
Hour Meter . . . . .	47

## I

Instrument Cluster . . . . .	45-49
------------------------------	-------

## J

Jetting Chart, 2X4 . . . . .	111
Jetting Chart, 4X4 . . . . .	114

## K

K-Turn . . . . .	62
------------------	----

# INDEX

## L

Light Switch	34
Lights	80-81
Low Range	86
Lubrication Guide	72

## M

Main Switch	35
MAINTENANCE AND LUBRICATION	68-107
Maintenance Record	73
Making Turns	55
Master Cylinder	37

## N

Noise Emission Control System	67
-------------------------------	----

## O

Odometer	47
Oil Change	75-76
Oil Check	75
OPERATION	50-66
Operator Safety	8-27
Override Switch	34

## P

Parking Brake	39
Parking on an Incline	66
Periodic Maintenance Chart	68-71
POLARIS PRODUCTS	108
Pre Ride Inspection	51
Premium 4 Synthetic Lubricant	74
Programmable Service Interval	48
PVT Drying	87
PVT System	86-87

## R

Rear Gearcase Oil	79
Rear Spring	94
Recoil Housing	85
Recoil Starter	43
Rider Information Center	46-49

## S

Safe Riding Gear	32
SAFETY	8-33
Safety Decals and Locations	28-31
Safety Training	8
Severe Use	68
Side Panel Removal	98
Sidehilling	60
Spark Arrestor	67, 84
Spark Plugs	82
SPECIFICATIONS	109-114
Starting a Cold Engine	52
Starting a Warm Engine	53
Starting the Engine	52-53
Steering Assembly	94
Stop Switch	35
Storage Tips	104-105

## T

TABLE OF CONTENTS	5
Taillight/Brakelight Lamp Replacement	81
Throttle Cable Freeplay	97
Throttle Lever	36
Tire Tread Depth	101
Toe Alignment	93
Transmission Gear Selector	42
Transmission Oil	77
Transporting an ATV	107
Trip Meter	47
TROUBLESHOOTING	115-118
Turning Around on a Hill	62

## V

VEHICLE IDENTIFICATION NUMBERS	7
Vehicle Immersion	83

## W

WARRANTY	119-121
Washing the ATV	103
Waxing the ATV	103
WELCOME	3
Wheel Installation	100
Wheel Nut Torque Specifications	100
Wheel Removal	99