

12 VOLT PLUG



P/N 2884938

APPLICATION

Verify accessory fitment at www.polaris.com.

IMPORTANT
Auxiliary Light Kit P/N 2889733 and P/N 2889863 are not compatible with 12 Volt Plug Kit.

BEFORE YOU BEGIN

Read these instructions and check to be sure all parts and tools are accounted for. Please retain these installation instructions for future reference and parts ordering information.

KIT CONTENTS

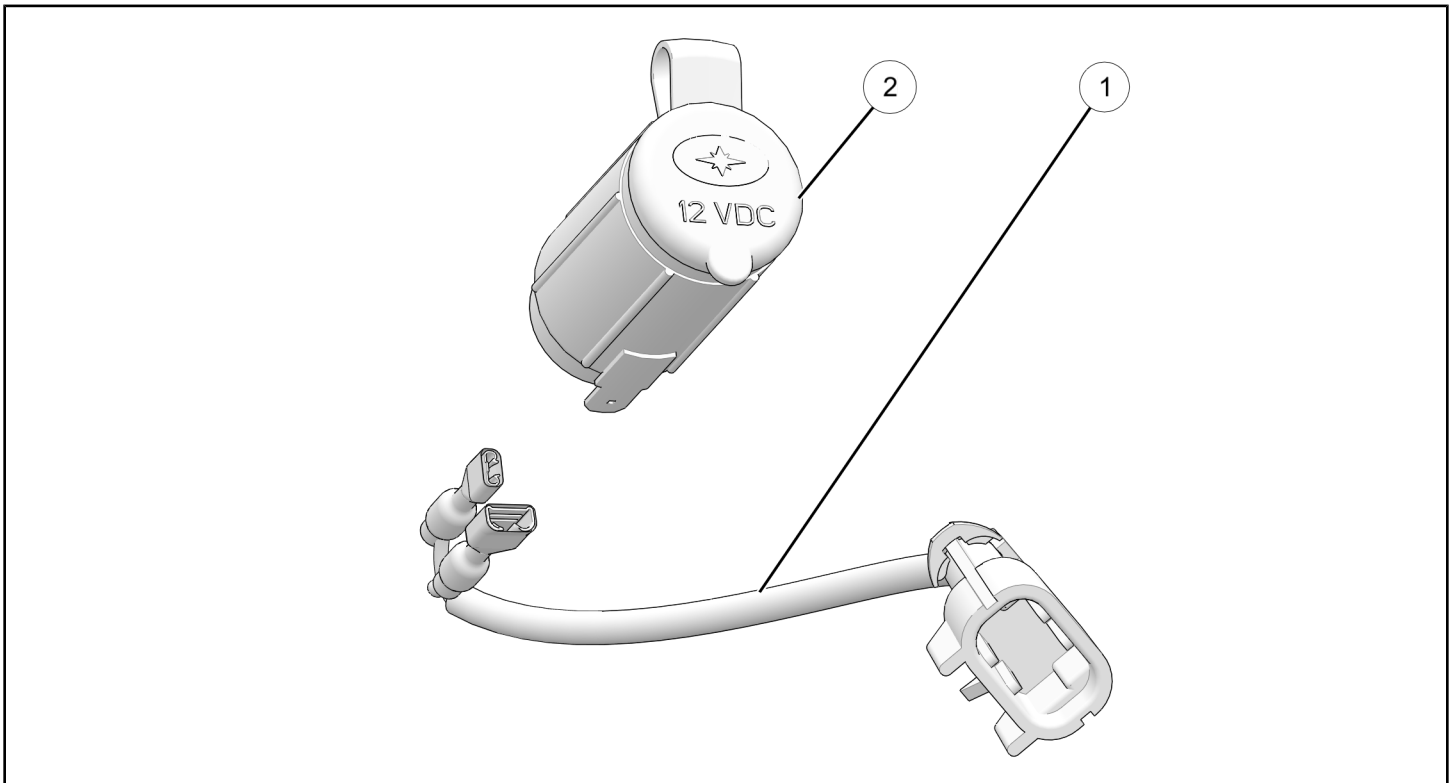

REF	QTY	PART DESCRIPTION	P/N AVAILABLE SEPARATELY
1	1	12V Outlet Harness	2415647
2	1	12V Receptacle	4010638

HARNES DETAIL

12V OUTLET HARNESS

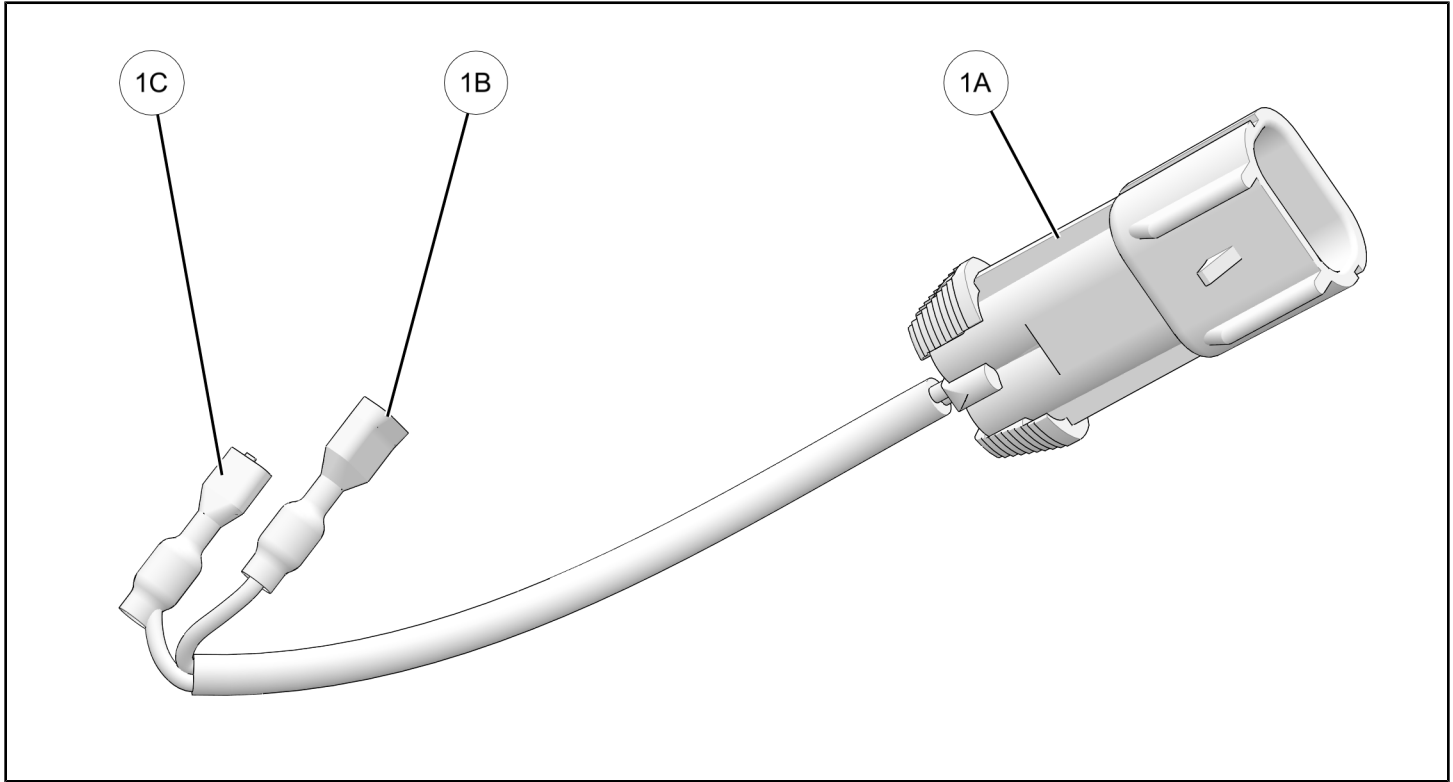

REF	PART DESCRIPTION	WIRE COLOR	PIN QTY/ GENDER	CONNECTS TO
1A	12V Hood Harness	—	2/Female	Hood Harness
1B	12V Ground	Brown	1/Female	12V Outlet
1C	12V Power	Red	1/Female	12V Outlet

TOOLS REQUIRED

- Safety Glasses
- Drill
- Hole Saw:
 - 7/8 in
- Scissors

IMPORTANT

Your 12 Volt Plug is exclusively designed for your vehicle. Please read the installation instructions thoroughly before beginning. Installation is easier if the vehicle is clean and free of debris. For your safety, and to ensure a satisfactory installation, perform all installation steps correctly in the sequence shown.

INSTALLATION INSTRUCTIONS

VEHICLE PREPARATION

GENERAL

1. Park snowmobile on a flat surface.
2. Push the engine stop switch down to the OFF position.
3. Turn the key to the OFF position and remove key.
4. Rotate the three 1/4 turn latches (A) and remove the side panel (B) by pulling the panel outward to release the tabs at the bottom. Repeat this step to remove the side panel from opposite side of the snowmobile.

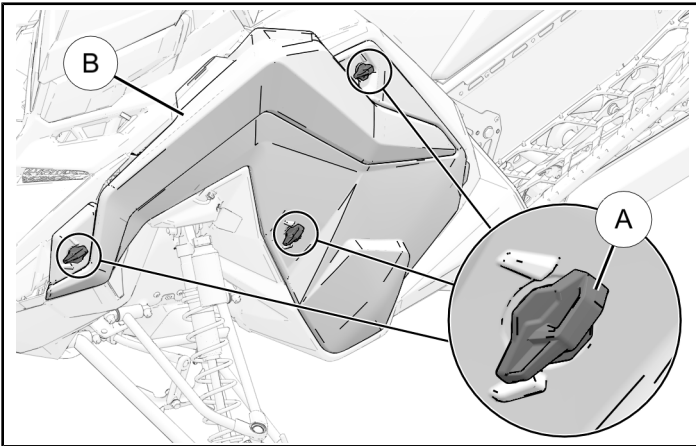

5. Rotate the 1/4 turn fasteners (C) at the rear corners of the hood.

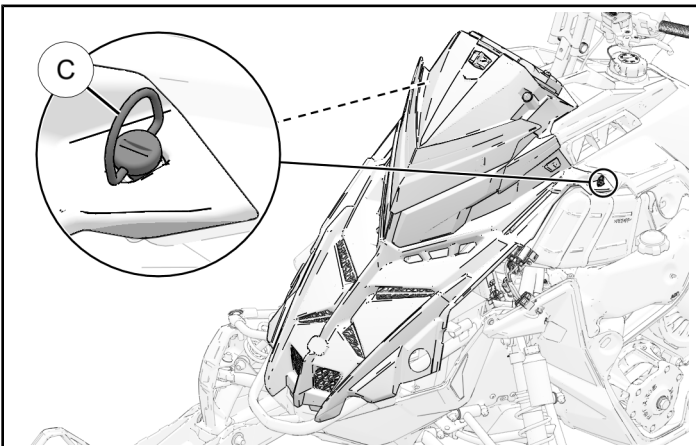

6. Disconnect the hood harness connector (D) from the main harness.

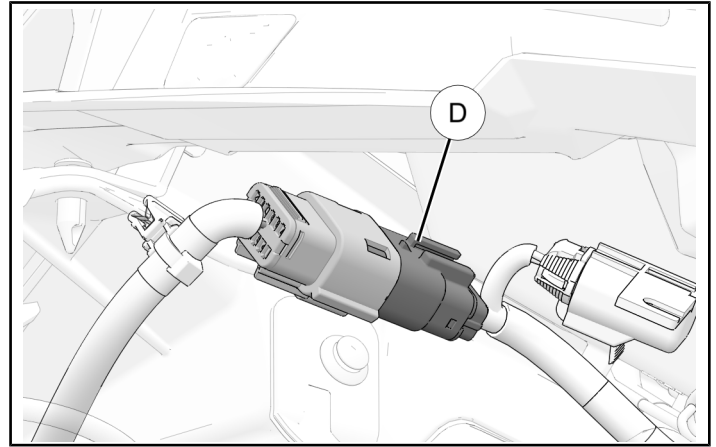

7. Remove the hood assembly (E) and place upside down on a flat surface.

NOTICE

Place the hood on a blanket or cardboard to protect the hood finish.

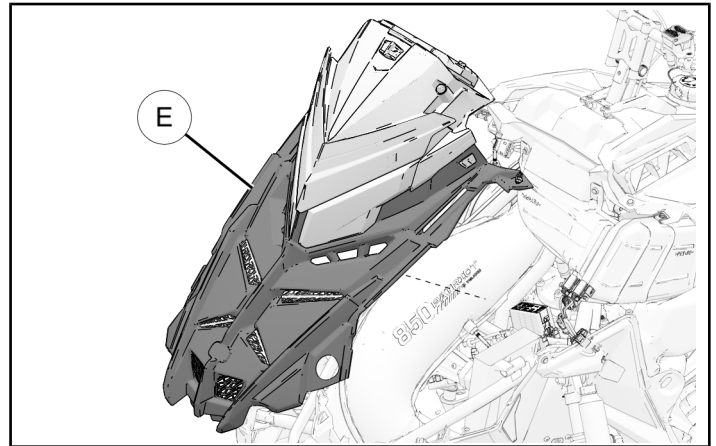

ACCESSORY INSTALLATION

1. Detach template page located at the end of this instruction.
2. Locate REFERENCE DIMENSION on each template page.

Verify REFERENCE DIMENSION is exact and template(s) were printed to proper scale.

NOTICE

If REFERENCE DIMENSION is not exact, reprint template page from electronic file. Adjust print setting to “**Actual Size**” to obtain 1:1 scale. Electronic file available from your **Authorized Dealer**.

3. Place 12V accessory template into position as shown and mark the location of the hole. Once marked, drill the required 7/8 inch hole in the hood.

NOTICE

If installing 12V Outlet on a Boost model, flip template over and drill hole opposite from side shown.

IMPORTANT

Control tool depth. Make sure tool is clear of all other parts and components to prevent damage to vehicle.

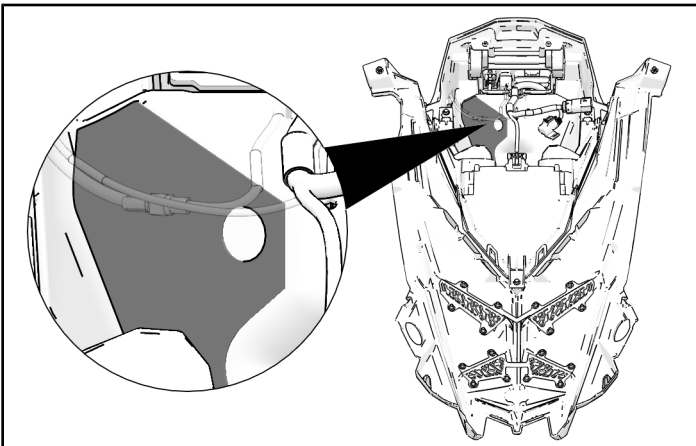

4. Remove the cap from the 12V accessory power connector.

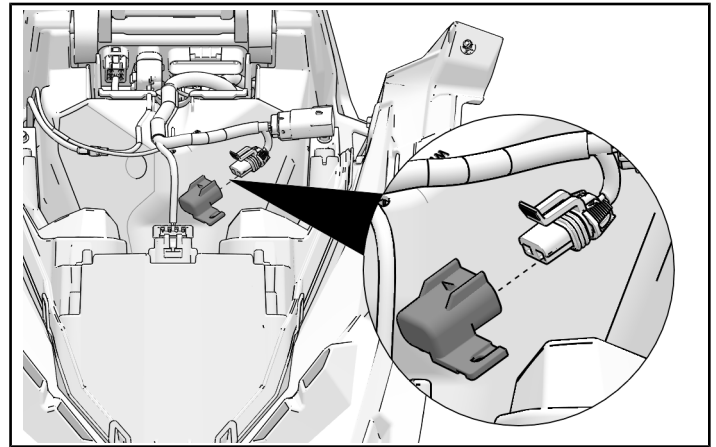

5. Connect the 12V outlet harness connector **1A** to the 12V accessory power connector.

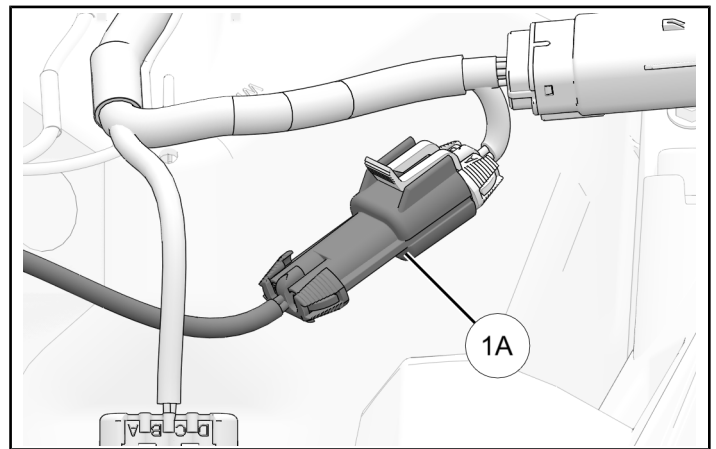

6. Slide the top latch and open the display door of the hood.

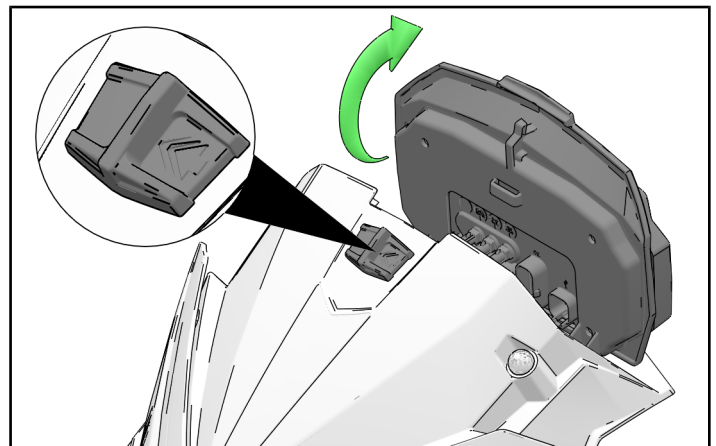

7. From inside the glove compartment, install the 12V receptacle ②.

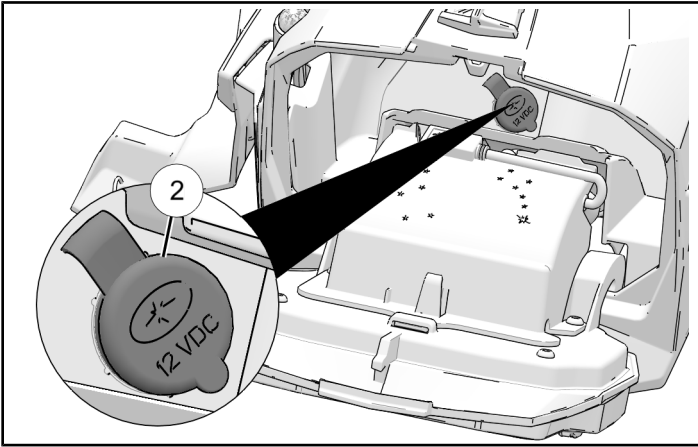

8. From the bottom side of the hood, install the 12V outlet harness leads 1B and 1C to the receptacle.

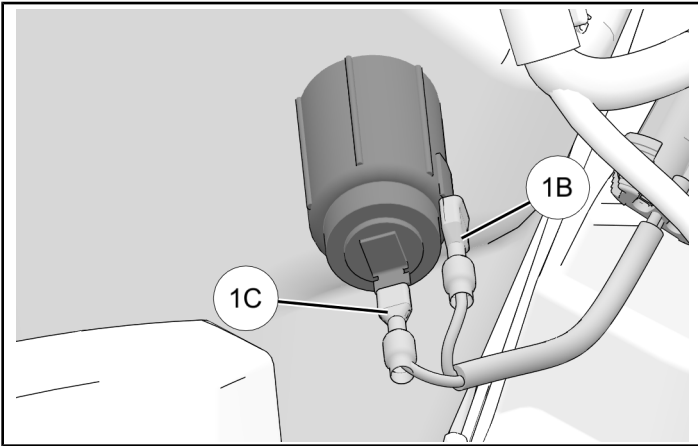

VEHICLE REASSEMBLY

GENERAL

1. Install the hood ⑤ by inserting the front of the hood into the nosepan.

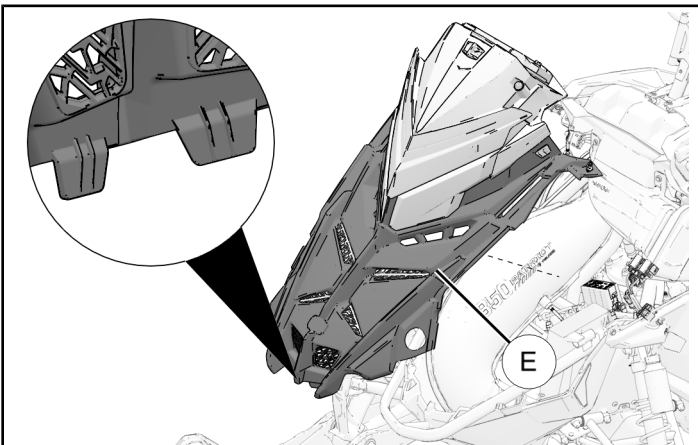

2. Connect the hood harness connector ④ to the main harness.

NOTICE

Verify the harness connectors are clean and dry prior to assembly.

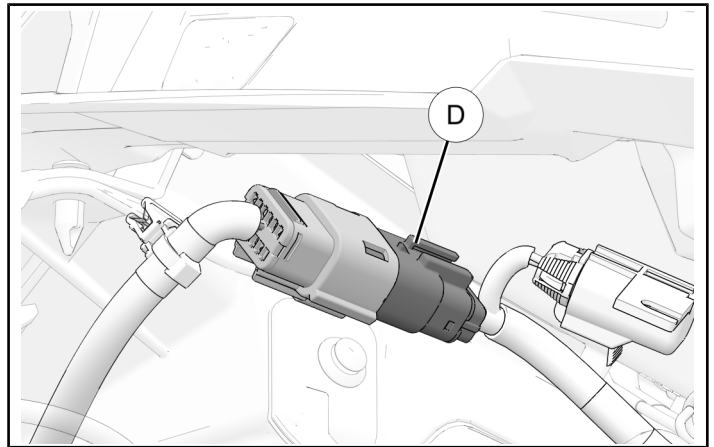

3. Rotate the 1/4 turn fasteners ③ at the rear corners of the hood to secure the rear of the hood to the console.

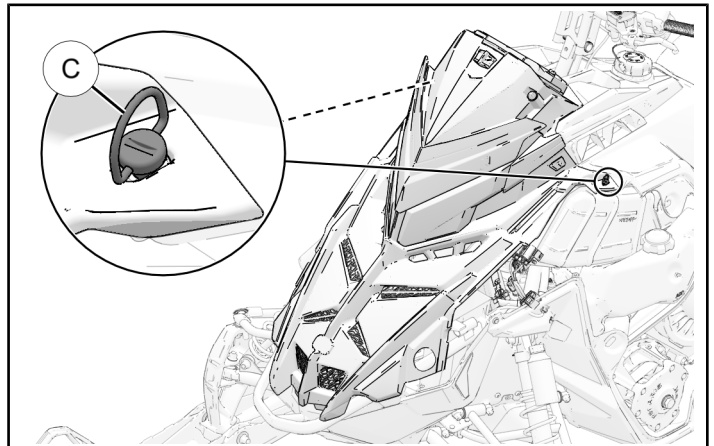

4. Align the tabs at the bottom of the side panel ⑥ with the slots in the fender and carefully insert.

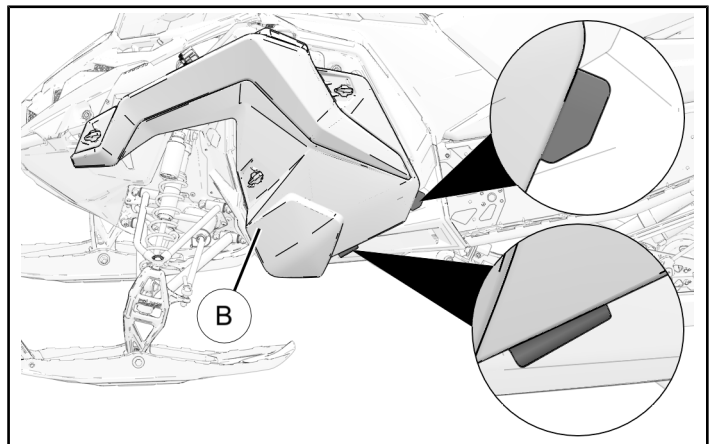

5. Close the side panel **(B)** and secure by rotating the three 1/4 turn latches **(A)**. Repeat this step to install the side panel onto opposite side of the snowmobile.

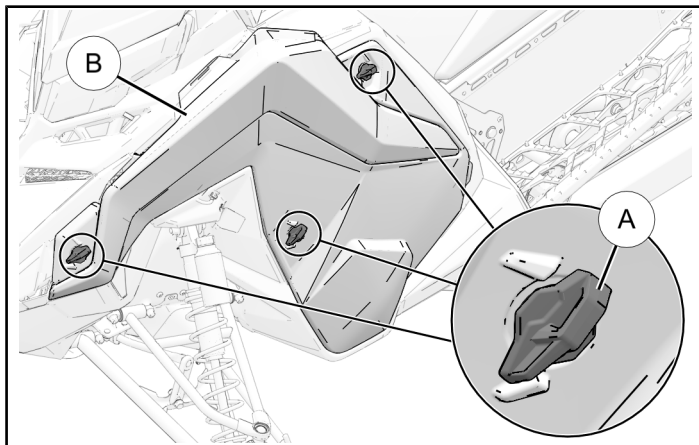

INSTRUCTION FEEDBACK FORM

A feedback form has been created for the installer to provide any comments, questions or concerns about the installation instructions. The form is viewable on mobile devices by scanning the QR code or by clicking [HERE](#) if viewing on a PC.



TEMPLATE

