

5301231
Model ATVBK-500
5 Nozzle Boom Assembly for ATV Mounting

ASSEMBLY / OPERATION INSTRUCTIONS / PARTS

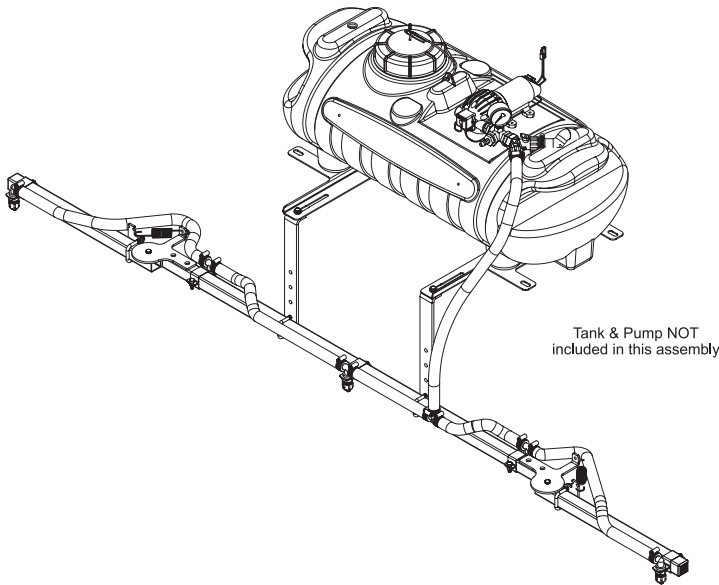

1. Attach the tank mount brackets and the boom mounting brackets to the tank with the hardware provided.
2. Center the center boom tube on the boom mounts and secure in place with the (2) u-bolts and whiz locknuts. Be sure that the outer booms will fold backwards. The boom should be about 18" above the ground.
3. Attach the nozzle harness assembly to the boom. The clamps should snap over the tubes so that the center and end nozzles are on the back side. The nozzles located close to the hinge should be on the front side of the tube. This will help prevent the hoses from kinking when the end booms are folded. The end booms should fold to the rear.
4. Join the 48" hose to the tee barb. Then clamp in place with a hose clamp.
5. Thread the fittings together as shown using a good grade of thread sealant to prevent leaking.

GENERAL INFORMATION

The purpose of this manual is to assist you in operating your sprayer. Please read it carefully as it furnishes information which will help you operate and maintain your sprayer.

WARRANTY / PARTS / SERVICE

Products are warranted for one year from date of purchase against manufacturer or workmanship defects.

Your authorized dealer is the best source of replacement parts and service. To obtain prompt, efficient service, always remember to give the following information.

1. Correct part description and part number.
2. Model number of your sprayer.
3. Serial number of your sprayer.

Part number and descriptions can be obtained from the illustrated parts list section of this manual. Whenever you need parts or repair service, contact your distributor / dealer first. For warranty work, always take your original sales slip, or other evidence of purchase date, to your distributor / dealer.

TECHNICAL SPECIFICATIONS

- 5 Nozzle Boom Assembly
- Break-Away Outer Booms
- 100 Inch Spray Coverage

ASSEMBLY INSTRUCTIONS

Remove the parts to the boom assembly from the carton. Refer to the parts list and picture to help identify the parts.

OPERATION AND CALIBRATION

The performance of any agricultural chemical depends upon the proper application of the correct amount. **Be sure that your equipment has been calibrated before spraying.**

The nozzles on the boom will spray a 110" wide pattern swath, however it is necessary to overlap patterns 30% to get proper coverages. The first pass will only cover 90" of overlapped spray. Each pass there after will provide a 100" swath of proper coverage. The proper nozzle height is 18 inches above the object being sprayed.

- Chemical labels may show application rates in gallons per acre, gallons per 1000 square feet, or gallons per 100 square feet. You will note that the tip chart shows all three of these rating systems.
- Four things must be considered before spraying with the boom.
 1. How much chemical must be mixed in the tank.
 2. Rate of spray (gallons per acre to be sprayed).
 3. What pressure (P.S.I.) will be used.
 4. Speed traveled (M.P.H.) while spraying.



WWW.FIMCOINDUSTRIES.COM

1000 FIMCO LANE • P.O. BOX 1700 • NO. SIOUX CITY, SD 57049
TOLL FREE: 800-831-0027 • TOLL FREE FAX: 800-494-0440
Form No. 730 (5004566 1/06) Printed In U.S.A.

- Refer to the chemical label to determine the chemical mixture.
- See the tip chart to determine the pressure to be used. The chart will also show the speed used when spraying.
- If the towing vehicle does not have a speedometer, speed can be determined as per the directions.

Once you know how much you are going to spray then determine (from the tip chart) the spraying pressure (PSI) and the spraying speed (MPH). The pressure can be set by running the sprayer with the boom nozzles "on", and then adjusting the relief valve until the gauge reads the desired pressure. Notice that the pressure will go up when the boom lines are shut off. This is normal, and the pressure will return as before when you open the boom lines.

When selecting pressure from the tip chart, it is a good idea to try for the 20 or 30 PSI range as this allows an excellent nozzle pattern. 10 PSI begins to break up the pattern, and at 40 PSI, you may notice some drift.

Conditions of weather and terrain must be considered when setting the sprayer. Do not spray on windy days. Protective clothing must be worn in some cases. Be sure to read the chemical label carefully.

Determining the proper speed of the towing vehicle can be done by marking off 100, 200, and 300 ft. The speed chart indicates the number of seconds it takes to travel the distances. Adjust the throttle until you travel the distances in the number of seconds indicated by the speed chart. Once you have reached the throttle setting needed, mark the throttle location so you can stop and go again (returning to the same speed).

The following situation is a typical spraying example. The chemical label says to apply 1.2 gallons of solution per 1000 sq. feet. Looking at the tip chart you see that you can spray 1.18 gallons per 1000 square feet at 30 PSI and 1 MPH. Let's say that it is a fairly still day and the ground is rough. The 30 PSI and 1 MPH will be all right for this spraying situation.

After measuring off the 100, 200, and 300 feet distances, prepare to make the trail runs. The speed chart lists the time

Ground Speed Chart

Speed in M.P.H. (Miles Per Hour)	Time Required in Seconds to Travel a distance of:		
	100 ft.	200 ft.	300 ft.
1.0	68	136	205
2.0	34	68	102
3.0	23	45	68
4.0	17	34	51
5.0	14	27	41
6.0	11	23	34
7.0	9.7	19	29
8.0	8.5	17	26
9.0	7.6	15	23
10	6.8	14	20

to be 68, 136, and 205 seconds. The sprayer does not need to be running at this time. It is best to start about 10 feet ahead of the starting mark so you will be at the set throttle speed by the time you reach the starting mark.

A stopwatch would be best to use for timing the travel but a watch with a second hand can be used. Check each distance separately. By doing this you can check yourself until the time is correct.

Once you have the throttle setting determined, mark the setting so you can return to it each time you want to spray at this rate.

When you are ready to spray mix chemical as follows. Add proper amount of water to the tank. Run the sprayer while adding chemical to the water. Do not spray through the boom at this time. This will allow solution to (bypass) return to the tank. The movement of solution through the bypass will aid in mixing the water and chemicals, but will not keep the chemicals in suspension. An agitation system is needed for that.

WINTER STORAGE

Drain all water out of the sprayer paying special attention to pump, valves, and spray gun. These items are especially prone to damage from chemicals and freezing weather.

The sprayer should be winterized before storage by pumping a solution of RV anti-freeze through the entire plumbing. Proper care and maintenance will prolong the life of the sprayer.

CAUTION: Never use a metal object or other sharp item for cleaning a nozzle tip. It is better to use a nozzle brush (not wire brush) or compressed air for tip cleaning.

RATE CHART FOR 8002 SPRAY TIP

Pressure P.S.I.	Capacity G.P.M.	Gallons Per Acre Based on Water - 20" Spacing						
		1 MPH 88 FPM	2 MPH 176 FPM	3 MPH 264 FPM	4 MPH 352 FPM	5 MPH 440 FPM	7.5 MPH 660 FPM	10 MPH 880 FPM
20	.14	41.8	20.9	14.0	10.5	8.4	5.6	4.2
30	.17	51.2	25.6	17.2	12.9	10.3	6.9	5.1
40	.20	59.2	29.6	19.8	14.9	11.9	7.9	5.9
50	.23	66.4	33.2	22.2	16.6	13.3	8.8	6.6

Pressure P.S.I.	Capacity G.P.M.	Gallons Per 1000 Sq. Ft. Based on Water - 20" Spacing						
		1 MPH 88 FPM	2 MPH 176 FPM	3 MPH 264 FPM	4 MPH 352 FPM	5 MPH 440 FPM	7.5 MPH 660 FPM	10 MPH 880 FPM
20	.14	.96	.48	.32	.24	.19	.13	.10
30	.17	1.18	.59	.39	.30	.24	.16	.12
40	.20	1.36	.68	.45	.34	.27	.18	.14
50	.23	1.52	.76	.51	.38	.31	.20	.15

Pressure P.S.I.	Capacity G.P.M.	Gallons Per 100 Sq. Ft. Based On Water - 20" Spacing						
		1 MPH 88 FPM	2 MPH 176 FPM	3 MPH 264 FPM	4 MPH 352 FPM	5 MPH 440 FPM	7.5 MPH 660 FPM	10 MPH 880 FPM
20	.14	.095	.048	.032	.024	.019	.012	.009
30	.17	.117	.059	.039	.029	.024	.015	.011
40	.20	.135	.068	.045	.034	.027	.018	.013
50	.23	.152	.076	.050	.038	.030	.020	.015

MPH = Miles Per Hour
 FPM = Feet Per Minute
 PSI = Pounds Per Square Inch
 GPM = Gallons Per Minute

Exploded View
ATVBK-500

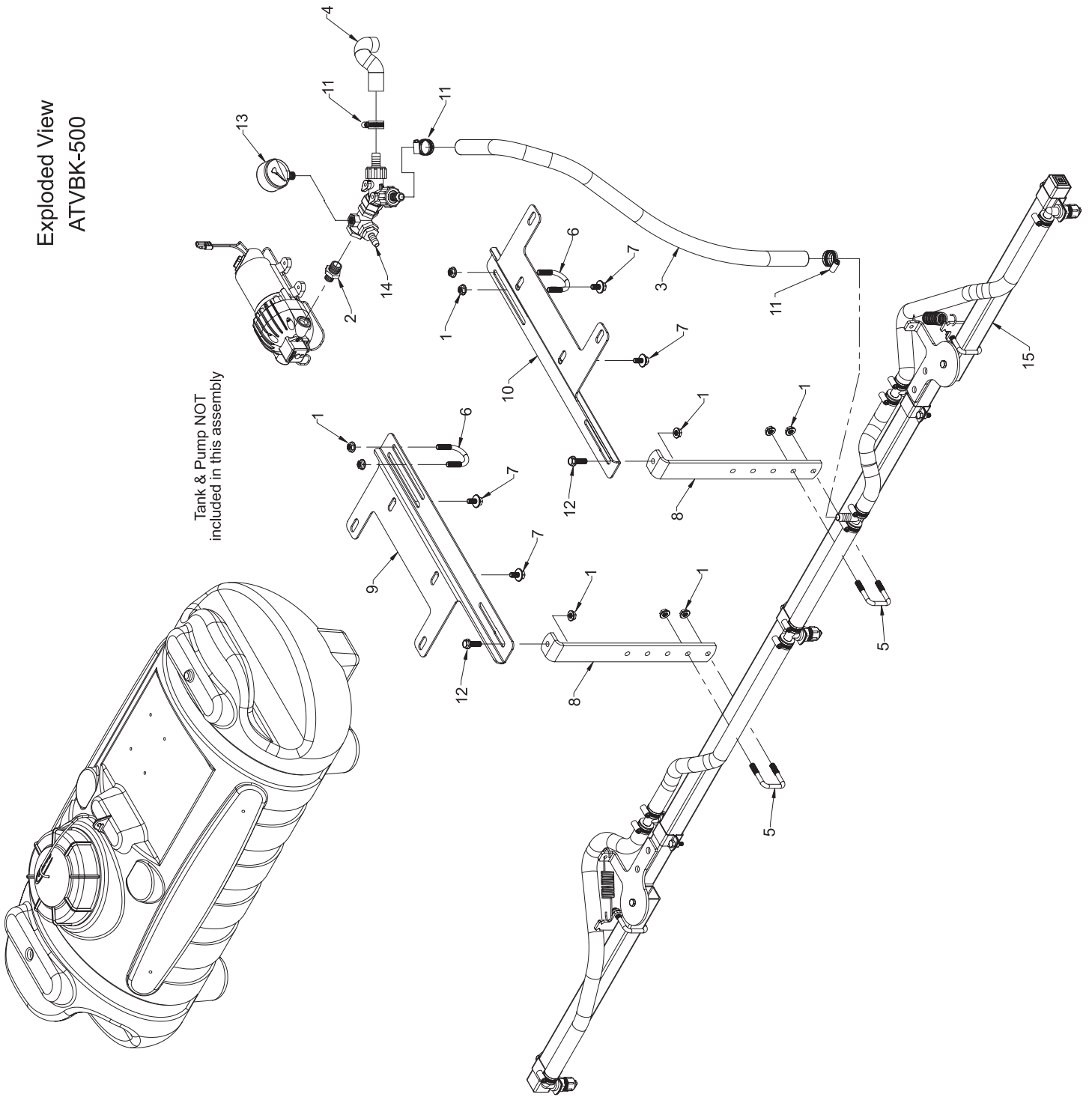

Repair Parts List for ATVBK-500

ITEM NO.	PART NUMBER	QTY.	DESCRIPTION
1	5006307	10	5/16"-18 Hex Whiz (Flange) Locknut
2	5011128	1	Nylon Reducing Nipple, 1/2" MNPT x 3/8" MNPT
3	5020122	1	Hose, 1/2"-1 Brd. x 48"
4	5020241	1	Hose, 1/2"-1 Brd. x 6"
5	5034159	2	Square U-Bolt, 5/16" x 1 5/16" x 1 7/8"
6	5034220	2	Round U-Bolt, 5/16"-18 x 1 5/16" x 1 3/4"
7	5034531	4	5/16"-18 x 5/8" Flange Lock Screw
8	5038506	2	Boom Mounting Bracket
9	5038667	1	Tank Mounting Plate (15 & 25 Gal.) (L.H.)
10	5038725	1	Tank Mounting Plate (15 & 25 Gal.) (R.H.)
11	5051022	3	Hose Clamp, 1/2"
12	5117300	2	5/16"-18 x 1" Flange Whiz Lock Screw
13	5167007	1	Gauge, 0-100 p.s.i.
14	5275118	1	Plumbing Sub-Assembly
15	BK-50	1	5-Nozzle Boom Assembly

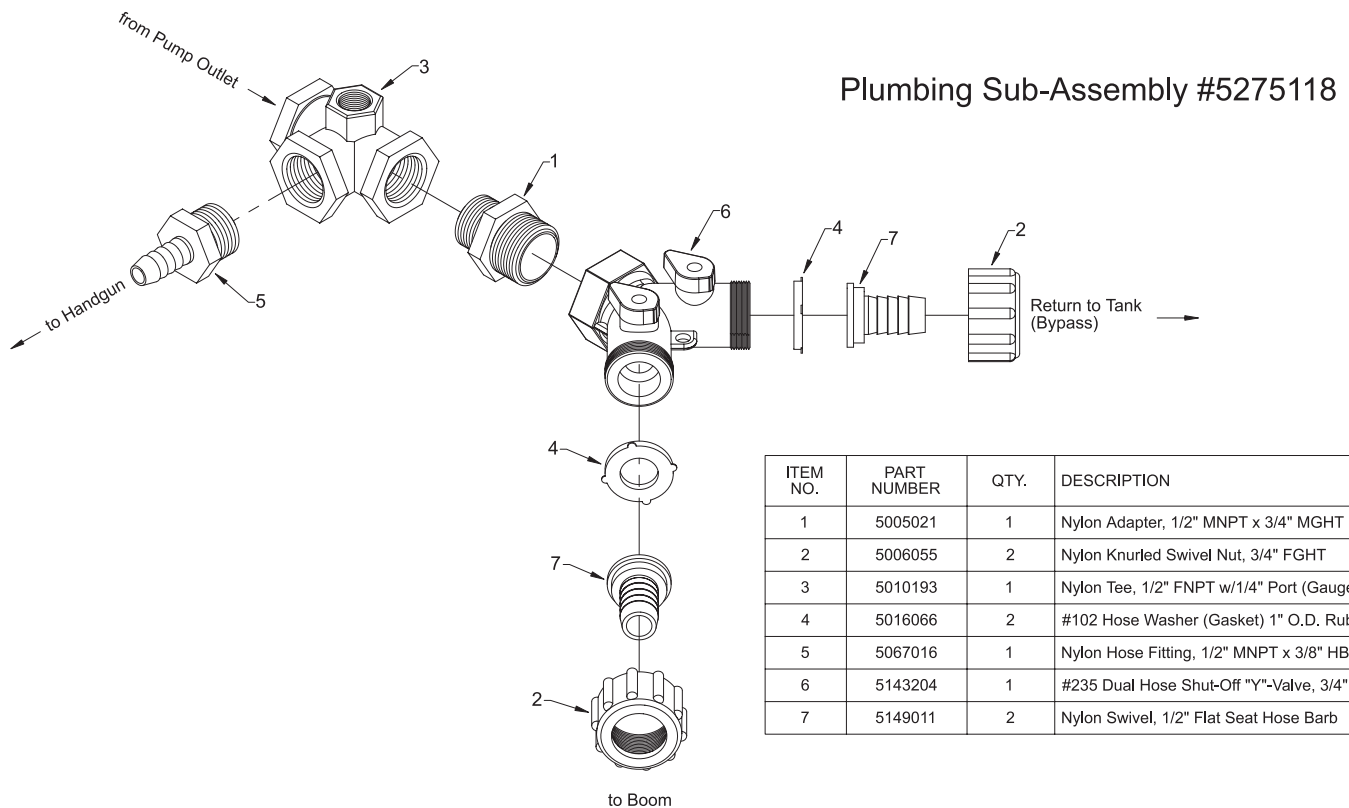

BK-50 Boom

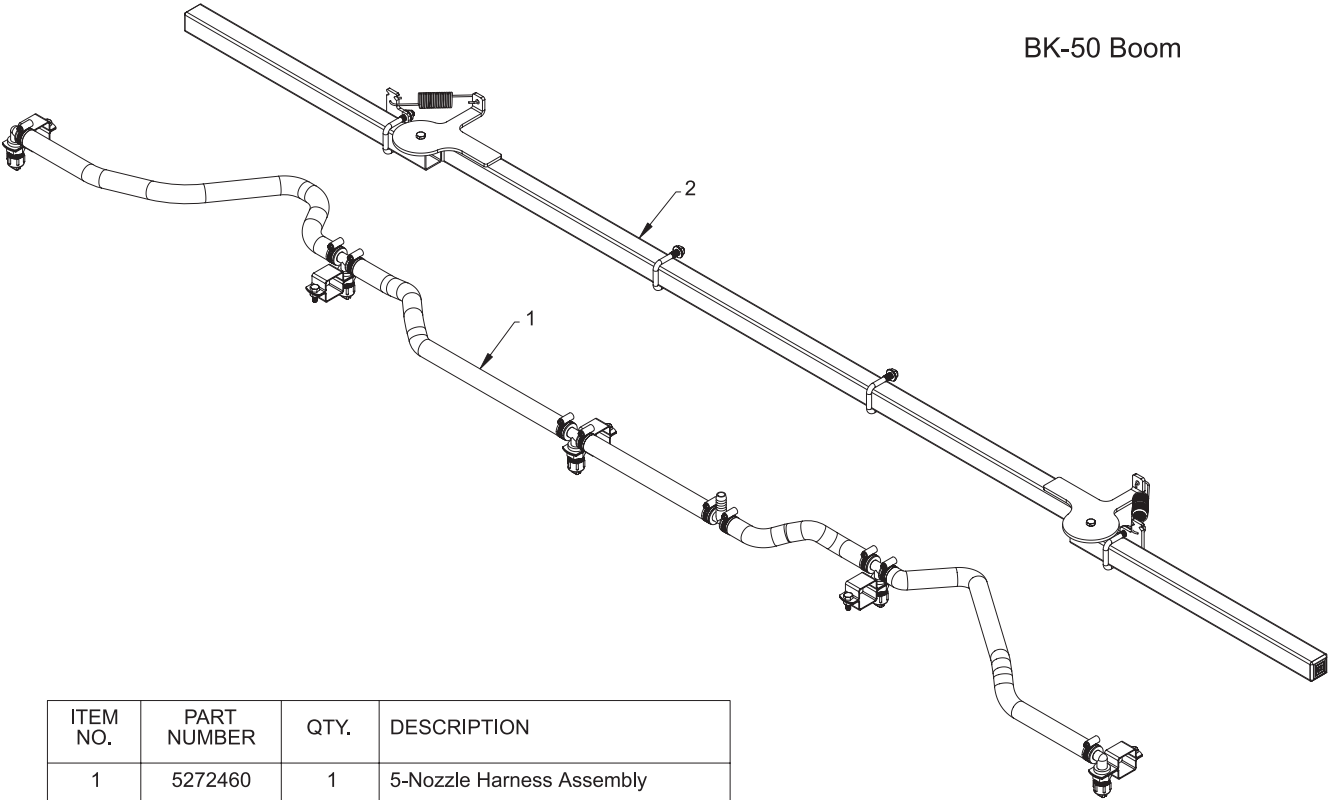

ITEM NO.	PART NUMBER	QTY.	DESCRIPTION
1	5272460	1	5-Nozzle Harness Assembly
2	5274361	1	5-Nozzle Boom Sub-Assembly

Nozzle Harness Assembly #5272460

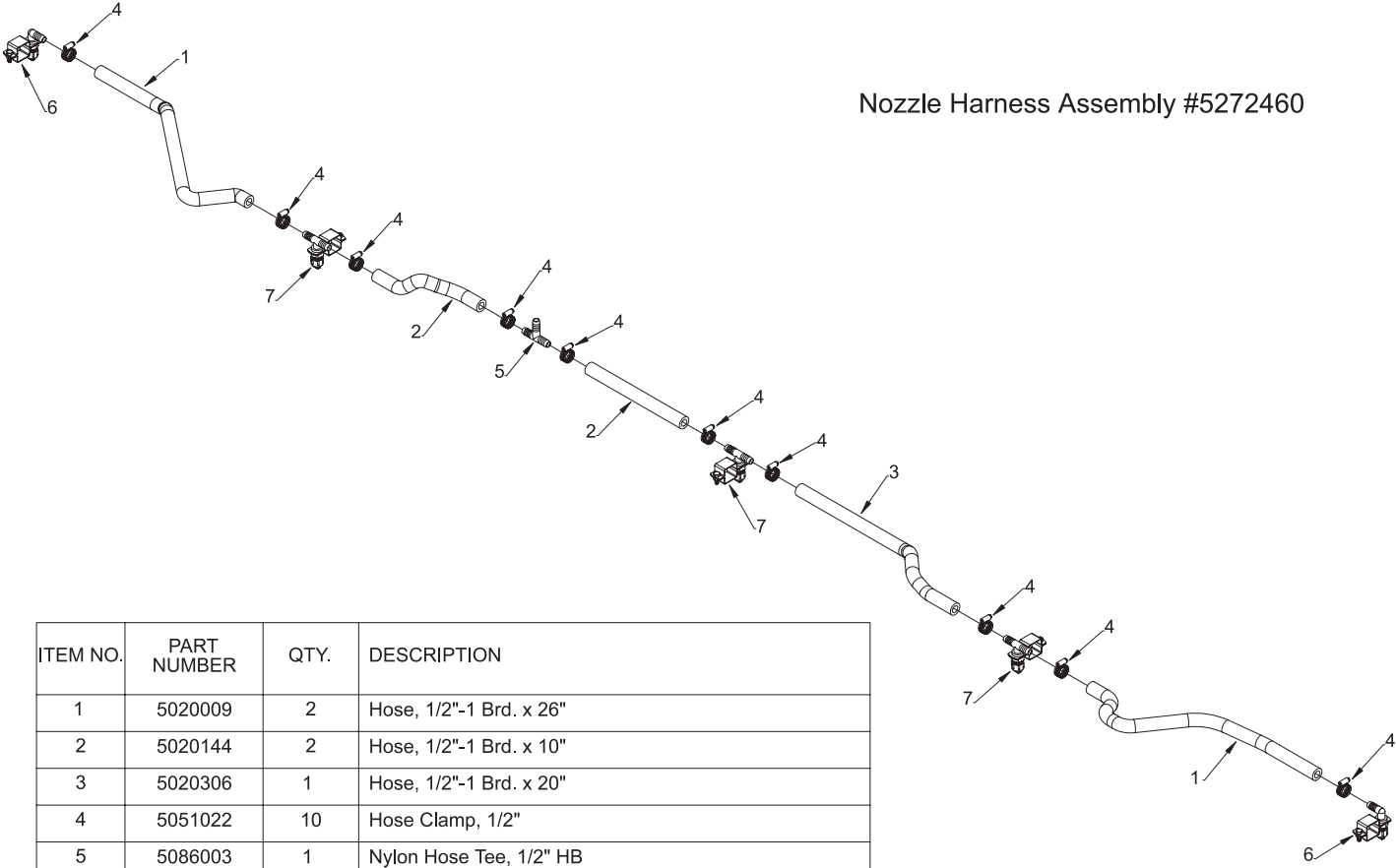

ITEM NO.	PART NUMBER	QTY.	DESCRIPTION
1	5020009	2	Hose, 1/2"-1 Brd. x 26"
2	5020144	2	Hose, 1/2"-1 Brd. x 10"
3	5020306	1	Hose, 1/2"-1 Brd. x 20"
4	5051022	10	Hose Clamp, 1/2"
5	5086003	1	Nylon Hose Tee, 1/2" HB
6	5275067	2	Standard "ELL" Nozzle Sub-Assembly (Square Tube)
7	5275068	3	Standard "Tee" Nozzle Sub-Assembly

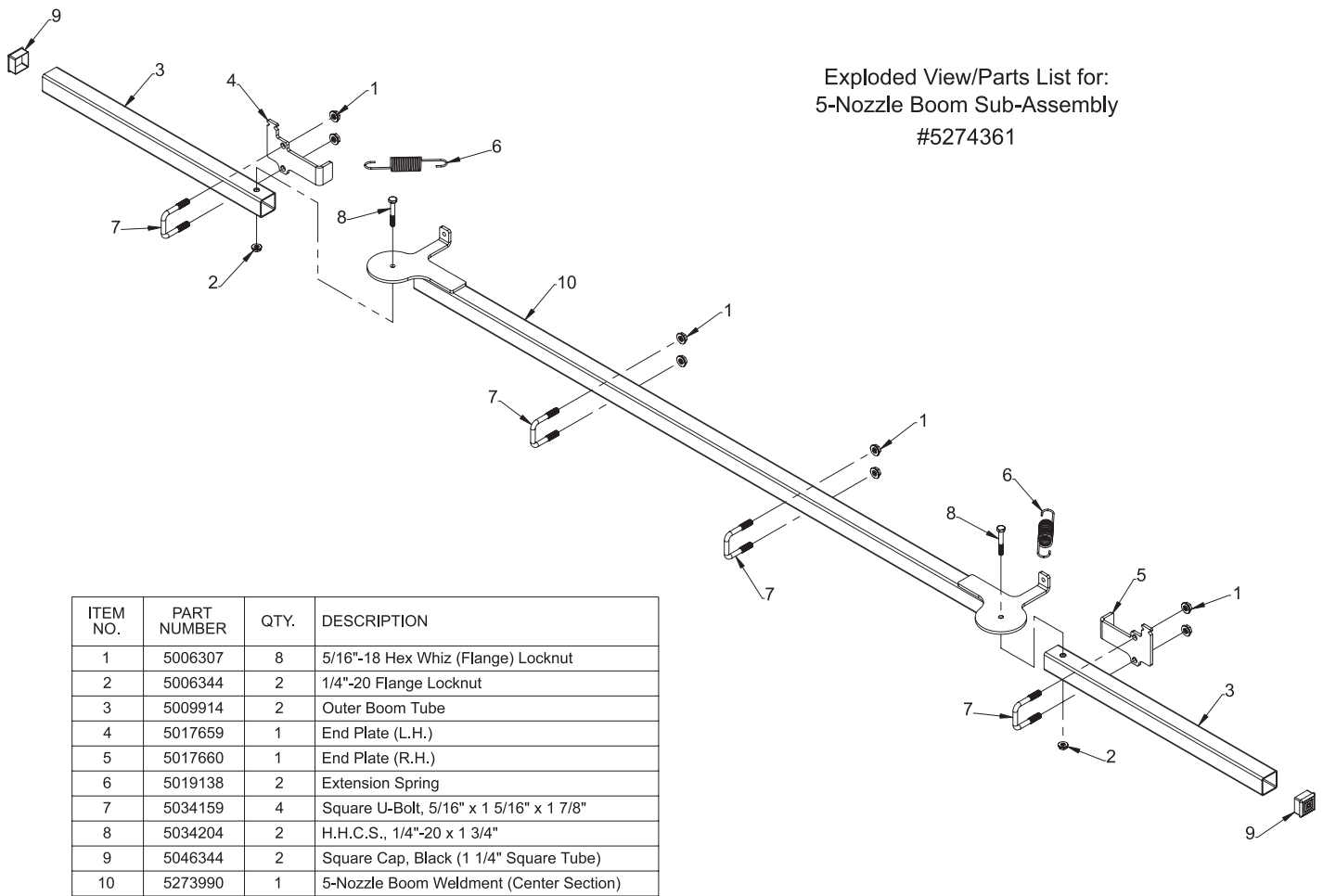

Nozzle Assembly #5275067

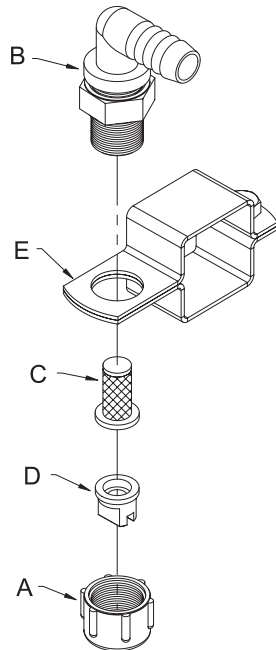

ITEM NO.	PART NUMBER	QTY.	DESCRIPTION
A	5046052	1	Nylon Nozzle Cap, 11/16" U.N.F. Thread
B	5056023	1	Nylon Elbow, 11/16" U.N.F. x 1/2" HB
C	5116019	1	PolyPro 50 Mesh Nozzle Strainer, Red
D	5138571	1	Lurmark Nylon Standard Flat Tip, 80 Degree, Yellow
E	5273796	1	1 1/4" Square Boom Nozzle Clamp (BC114)

Nozzle Assembly #5275068

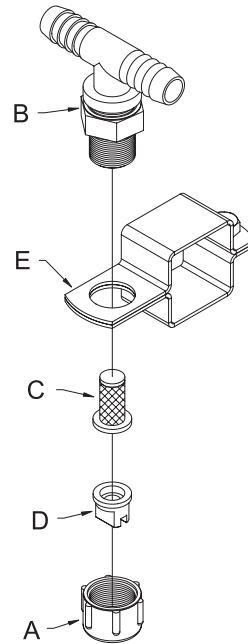

ITEM NO.	PART NUMBER	QTY.	DESCRIPTION
A	5046052	1	Nylon Nozzle Cap, 11/16" U.N.F. Thread
B	5056027	1	Nylon Tee, 11/16" U.N.F. x 1/2" HB-1/2" HB
C	5116019	1	PolyPro 50 Mesh Nozzle Strainer, Red
D	5138571	1	Lurmark Nylon Standard Flat Tip, 80 Degree, Yellow
E	5273796	1	1 1/4" Square Boom Nozzle Clamp (BC114)